

Inhalt

Seite



EIN-AUS-Schalter für Einbau 4-Lochbefestigung

306



EIN-AUS-Schalter für Zentralbefestigung

307



EIN-AUS-Schalter für Bodenmontage

308



EIN-AUS-Schalter für Reiheneinbau

309



Hauptschalter für Einbau 4-Lochbefestigung

310



Hauptschalter für Zentralbefestigung

311



Hauptschalter für Bodenmontage

312



Hauptschalter für Reiheneinbau

313



Hauptschalter, isolierstoffgekapselt

314



Technische Daten
Approbationen
Maße

315

319

325

Schütze, Motorstarter

Leistungsschalter

Motorschutzschalter

Schalter

AC-Hauptschalter

DC-Lasttrennschalter

Befehls- und Meldergeräte

Vertretungen, Bezugsquellen

Nennwerte				DC-Lasttrennschalter				
Typ	I _{th} offen A	DC21B(DC-PV1) bei U _e		Bauformen	Fronteinbau Vierlochbefestigung IP66 ¹⁾	Zentral- mit Türkupplung Ø22,5mm IP66 ¹⁾	Verteilereinbau IP40 ¹⁾ IP66 ¹⁾	Reiheneinbau
		4 Kontakte in Serie A	V					
LS16	16	16	1000	.. E Z(O) VZV SMA ..	
LS25	25	25	1000	.. E Z(O) VZV SMA ..	
LS32	32	32	1000	.. E Z(O) VZV SMA ..	
LS40	40	25	1000	.. E ..	-	.. VZV SMA ..	
LS55	55	32	1000	.. E ..	-	.. VZV SMA ..	

Lasttrennschalter für Photovoltaik

Gemäß IEC 60364-7-712 „Errichten von Photovoltaik-Versorgungssystemen“ ist eine Einrichtung zum Trennen (= Lasttrennschalter) der Photovoltaik-Module vom Wechselrichter verbindlich vorgeschrieben.

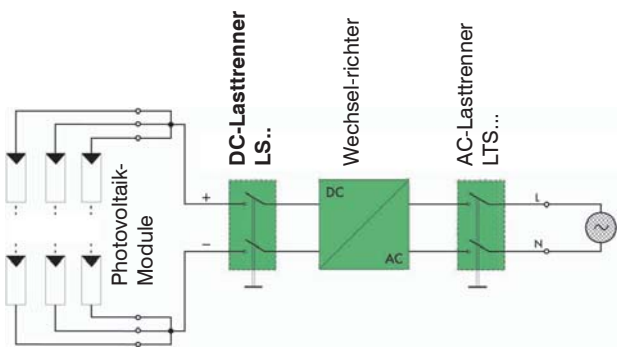

Lasttrennschalter „LS“ gewährleisten ein zuverlässiges Schalten von bis zu 85A bei 1500V in der Kategorie DC21B (DC-PV1).

Die Kontakte sind gegen Oxidation (geringe Schalthäufigkeit) und somit gegen unzulässige Erwärmung geschützt.

Der Lasttrennschalter ist mit 2, 4, 6 oder 8 schaltbaren, einzelnen Kontakten ausgestattet. Durch Serien- und Parallelschaltung der Kontakte kann die Schaltleistung entsprechend erhöht werden.

Die hohe Schaltgeschwindigkeit der Kontakte ist unabhängig von der Betätigungsgeschwindigkeit des Handgriffes.

Schaltprogramme

Typ	2-polig	2+2-polig 2 Pole in Serie + 2 Pole parallel	4-polig	4-polig mit Brücken Einspeisung oben Abgang unten	4-polig 2 Brücken oben Einspeisung und Abgang unten	4-polig 2 Brücken unten Einspeisung und Abgang oben
LS16	.. A2	.. A2+2	.. A4(2 x A2)	.. A4B	.. A4O	.. A4U
LS25	.. A2	.. A2+2	.. A4(2 x A2)	.. A4B	.. A4O	.. A4U
LS32	.. A2	.. A2+2	.. A4(2 x A2)	.. A4B	.. A4O	.. A4U
LS40	.. A2	.. A2+2	.. A4(2 x A2)	.. A4B	.. A4O	.. A4U
LS55	.. A2	.. A2+2	.. A4(2 x A2)	.. A4B	.. A4O	.. A4U

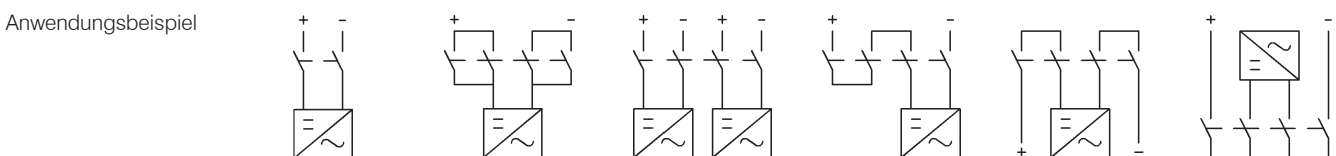
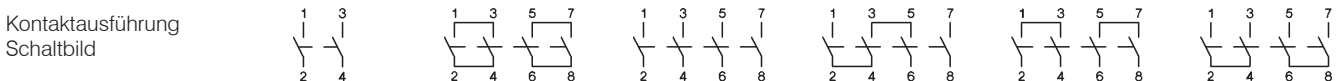

Bestellanleitung

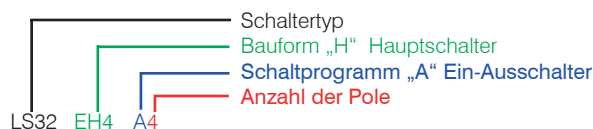

1) Schutzart von vorne im eingebauten Zustand

DC-Hauptschalter

Fronteinbau
Vierlochbefestigung
IP66¹⁾



Zentralbefestigung
Ø22,5mm
IP66¹⁾



Verteilereinbau
mit Türkupplung
IP66¹⁾



Reiheneinbau
IP40¹⁾



Preßstoffgekapsett
PFL..IP67



.. EH4. Z(O)H1 VZVH4 SMAH1 PFLH4 ..
.. EH4. Z(O)H1 VZVH4 SMAH1 PFLH4 ..
.. EH4. Z(O)H1 VZVH4 SMAH1 PFLH4 ..
.. EH4. ..	-	.. VZVH4 SMAH1 PFLH4 ..
.. EH4. ..	-	.. VZVH4 SMAH1 PFLH4 ..

Technische Daten für DC, nach IEC 60947-3, VDE0660, weitere Daten siehe Seite 309

Typ		DC21A/B (DC-PV1)							DC22B				
		500V	600V	700V	800V	900V	1000V	1200V	1500V	500V	600V	800V	1000V
2 Pole in Serie 	LS16 ..	16A	16A	16A	16A	16A	10A	7A	3A	7A	5,5A	2A	1A
	LS25..	25A	25A	25A	19A	17A	11,5A	8,5A	5A	8A	6A	2,5A	1,5A
	LS32 ..	32A	32A	32A	21A	18A	13A	10A	6A	9A	6,5A	3A	2A
	LS40 ..	40A	40A	37A	35A	31A	29A	11A	7,5A	-	-	-	-
	LS55..	55A	55A	55A	55A	43A	36A	17A	10A	-	-	-	-
2 Pole in Serie+2 parallel 	LS16 ..	29A	29A	22A	17A	16A	10A	7A	3A	-	-	-	-
	LS25..	45A	36A	27A	19A	17A	12A	9A	5A	-	-	-	-
	LS32 ..	58A	55A	32A	21A	18A	13A	10A	6A	-	-	-	-
	LS40 ..	72A	72A	49A	42A	31A	29A	11A	7,5A	-	-	-	-
	LS55..	85A	85A	77A	63A	43A	36A	17A	10A	-	-	-	-
4 Pole in Serie 	LS16 ..	16A	16A	16A	16A	16A	16A	16A	16A	16A	16A	11,5A	8A
	LS25..	25A	25A	25A	25A	25A	25A	25A	25A	25A	25A	12A	9A
	LS32 ..	32A	32A	32A	32A	32A	32A	32A	32A	32A	32A	27,5A	10A
	LS40 ..	40A	40A	40A	40A	40A	40A	40A	40A	40A	40A	12,5A	10A
	LS55..	55A	55A	55A	55A	55A	55A	55A	55A	55A	55A	-	-
4 Pole in Serie+2 parallel 	LS16 ..	29A	29A	29A	29A	29A	29A	29A	20A	-	-	-	-
	LS25..	45A	45A	45A	45A	45A	45A	45A	26A	-	-	-	-
	LS32 ..	58A	58A	58A	58A	58A	58A	50A	32A	-	-	-	-
	LS40 ..	72A	72A	72A	72A	72A	72A	56A	42A	-	-	-	-
	LS55 ..	85A	85A	85A	85A	85A	85A	65A	55A	-	-	-	-

Schaltprogramme

Typ	6-polig	3+2-polig 3 Pole in Serie +2 Pole parallel	8-polig	4+2-polig 4 Pole in serie +2 Pole parallel
LS16	...A6	.. A3+2	...A8	.. A4+2
LS25	...A6	.. A3+2	...A8	.. A4+2
LS32	...A6	.. A3+2	...A8	.. A4+2
LS40	...A6	.. A3+2	...A8	.. A4+2
LS55	...A6	.. A3+2	...A8	.. A4+2
Kontaktausführung Schaltbilder				
Anwendungsbeispiele				

Isolierter Verbinder LSV... für Serien- und Parallelschaltung von Kontakten



Typ	VPE	Gewicht
LS16, LS25, LS32	100	6,6 g/Stk.
LS40, LS55	100	9,64 g/Stk.

Ein-Aus-Schalter, Fronteinbau m. Vierlochbefestigung, Schild 64[□], Schutzart IP66, Typ 3R



DC21B / DC-PV1 600V DC 1000V DC	Anzahl Pole in Serie	Anzahl Strings	Typ	VPE Stk.	Gewicht kg/Stk.
16A 10A	2	1	LS16 E A2	1	0,20
25A 11,5A	2	1	LS25 E A2	1	0,20
32A 13A	2	1	LS32 E A2	1	0,20
40A 29A	2	1	LS40 E A2	1	0,41
55A 36A	2	1	LS55 E A2	1	0,41

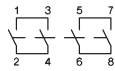

29A 10A	2	1	LS16 E A2+2	1	0,25
36A 11,5A	2	1	LS25 E A2+2	1	0,25
55A 13A	2	1	LS32 E A2+2	1	0,25
68A 29A	2	1	LS40 E A2+2	1	0,54
85A 36A	2	1	LS55 E A2+2	1	0,54

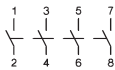

16A 10A	2	2	LS16 E A4	1	0,23
25A 11,5A	2	2	LS25 E A4	1	0,23
32A 13A	2	2	LS32 E A4	1	0,23
40A 29A	2	2	LS40 E A4	1	0,49
55A 36A	2	2	LS55 E A4	1	0,49

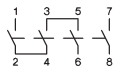

16A 16A	4	1	LS16 E A4B	1	0,24
25A 25A	4	1	LS25 E A4B	1	0,24
32A 32A	4	1	LS32 E A4B	1	0,24
40A 40A	4	1	LS40 E A4B	1	0,52
55A 55A	4	1	LS55 E A4B	1	0,52

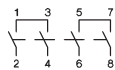

16A 16A	4	1	LS16 E A4O	1	0,24
25A 25A	4	1	LS25 E A4O	1	0,24
32A 32A	4	1	LS32 E A4O	1	0,24
40A 40A	4	1	LS40 E A4O	1	0,52
55A 55A	4	1	LS55 E A4O	1	0,52

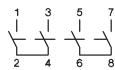

16A 16A	4	1	LS16 E A4U	1	0,24
25A 25A	4	1	LS25 E A4U	1	0,24
32A 32A	4	1	LS32 E A4U	1	0,24
40A 40A	4	1	LS40 E A4U	1	0,52
55A 55A	4	1	LS55 E A4U	1	0,52

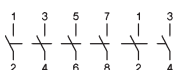

16A 10A	2	3	LS16 E A6	1	0,36
25A 11,5A	2	3	LS25 E A6	1	0,36
32A 13A	2	3	LS32 E A6	1	0,36
40A 29A	2	3	LS40 E A6	1	0,99
55A 36A	2	3	LS55 E A6	1	0,99

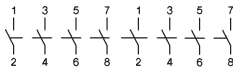

16A 10A	2	4	LS16 E A8	1	0,41
25A 11,5A	2	4	LS25 E A8	1	0,41
32A 13A	2	4	LS32 E A8	1	0,41
40A 29A	2	4	LS40 E A8	1	1,09
55A 36A	2	4	LS55 E A8	1	1,09

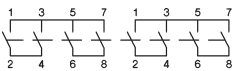

29A 29A	4	1	LS16 E A4+2	1	0,46
45A 45A	4	1	LS25 E A4+2	1	0,46
58A 58A	4	1	LS32 E A4+2	1	0,46
72A 72A	4	1	LS40 E A4+2	1	1,20
85A 85A	4	1	LS55 E A4+2	1	1,20

Verlängerte Schalterwelle für Schalter für Fronteinbau

Typenzusatz

+VW"x"

x = Paneelstärke

Ein-Aus-Schalter, Zentralbefestigung Ø22mm, Schild 48³, Schutzart IP66, Typ 4X



DC21B / DC-PV1 600V DC	DC	1000V DC	Anzahl Pole in Serie	Anzahl Strings	Typ	VPE Stk.	Gewicht kg/Stk.
16A	10A		2	1	LS16 Z A2	1	0,21
25A	11,5A		2	1	LS25 Z A2	1	0,21
32A	13A		2	1	LS32 Z A2	1	0,21

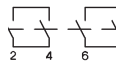

29A	10A		2	1	LS16 Z A2+2	1	0,26
36A	11,5A		2	1	LS25 Z A2+2	1	0,26
55A	13A		2	1	LS32 Z A2+2	1	0,26

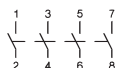

16A	10A		2	2	LS16 Z A4	1	0,23
25A	11,5A		2	2	LS25 Z A4	1	0,23
32A	13A		2	2	LS32 Z A4	1	0,23

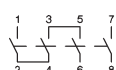

16A	16A		4	1	LS16 Z A4B	1	0,25
25A	25A		4	1	LS25 Z A4B	1	0,25
32A	32A		4	1	LS32 Z A4B	1	0,25

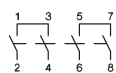

16A	16A		4	1	LS16 Z A4O	1	0,25
25A	25A		4	1	LS25 Z A4O	1	0,25
32A	32A		4	1	LS32 Z A4O	1	0,25

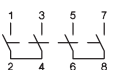

16A	16A		4	1	LS16 Z A4U	1	0,25
25A	25A		4	1	LS25 Z A4U	1	0,25
32A	32A		4	1	LS32 Z A4U	1	0,25

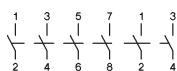

16A	10A		2	3	LS16 Z A6	1	0,38
25A	11,5A		2	3	LS25 Z A6	1	0,38
32A	13A		2	3	LS32 Z A6	1	0,38

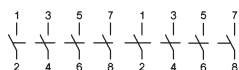

16A	10A		2	4	LS16 Z A8	1	0,43
25A	11,5A		2	4	LS25 Z A8	1	0,43
32A	13A		2	4	LS32 Z A8	1	0,43

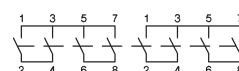

29A	29A		4	1	LS16 Z A4+2	1	0,48
45A	45A		4	1	LS25 Z A4+2	1	0,48
58A	58A		4	1	LS32 Z A4+2	1	0,48

Ein-Aus-Schalter, Zentralbefestigung Ø22mm, ohne Schild, Schutzart IP66, Typ 4X



bei Type „Z“ durch „ZO“ ersetzen **LS.. ZO A.**

Ein-Aus-Schalter, Bodenmontage, Türkupplung für Zentralbefestigung, Schild 64[□], IP66, c Typ 4X

DC21B / DC-PV1 Anzahl Pole Anzahl Typ VPE Gewicht
 600V DC 1000V DC in Serie Strings Stk. kg/Stk.



16A	10A	2	1	LS16 VZV A2	1	0,22
25A	11,5A	2	1	LS25 VZV A2	1	0,22
32A	13A	2	1	LS32 VZV A2	1	0,22
40A	29A	2	1	LS40 VZV A2	1	0,51
55A	36A	2	1	LS55 VZV A2	1	0,51

Einbautiefe einstellbar

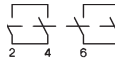

29A	10A	2	1	LS16 VZV A2+2	1	0,27
36A	11,5A	2	1	LS25 VZV A2+2	1	0,27
55A	13A	2	1	LS32 VZV A2+2	1	0,27
68A	29A	2	1	LS40 VZV A2+2	1	0,55
85A	36A	2	1	LS55 VZV A2+2	1	0,55

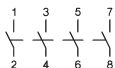

16A	10A	2	2	LS16 VZV A4	1	0,25
25A	11,5A	2	2	LS25 VZV A4	1	0,25
32A	13A	2	2	LS32 VZV A4	1	0,25
40A	29A	2	2	LS40 VZV A4	1	0,56
55A	36A	2	2	LS55 VZV A4	1	0,56

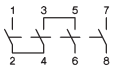

16A	16A	4	1	LS16 VZV A4B	1	0,26
25A	25A	4	1	LS25 VZV A4B	1	0,26
32A	32A	4	1	LS32 VZV A4B	1	0,26
40A	40A	4	1	LS40 VZV A4B	1	0,58
55A	55A	4	1	LS55 VZV A4B	1	0,58

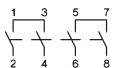

16A	16A	4	1	LS16 VZV A4O	1	0,26
25A	25A	4	1	LS25 VZV A4O	1	0,26
32A	32A	4	1	LS32 VZV A4O	1	0,26
40A	40A	4	1	LS40 VZV A4O	1	0,58
55A	55A	4	1	LS55 VZV A4O	1	0,58

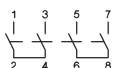

16A	16A	4	1	LS16 VZV A4U	1	0,26
25A	25A	4	1	LS25 VZV A4U	1	0,26
32A	32A	4	1	LS32 VZV A4U	1	0,26
40A	40A	4	1	LS40 VZV A4U	1	0,58
55A	55A	4	1	LS55 VZV A4U	1	0,58

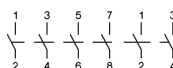

16A	10A	2	3	LS16 VZV A6	1	0,38
25A	11,5A	2	3	LS25 VZV A6	1	0,38
32A	13A	2	3	LS32 VZV A6	1	0,38
40A	29A	2	3	LS40 VZV A6	1	1,00
55A	36A	2	3	LS55 VZV A6	1	1,00

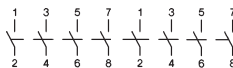

16A	10A	2	4	LS16 VZV A8	1	0,43
25A	11,5A	2	4	LS25 VZV A8	1	0,43
32A	13A	2	4	LS32 VZV A8	1	0,43
40A	29A	2	4	LS40 VZV A8	1	1,10
55A	36A	2	4	LS55 VZV A8	1	1,10

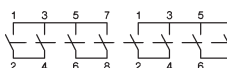

29A	29A	4	1	LS16 VZV A4+2	1	0,48
45A	45A	4	1	LS25 VZV A4+2	1	0,48
58A	58A	4	1	LS32 VZV A4+2	1	0,48
72A	72A	4	1	LS40 VZV A4+2	1	1,21
85A	85A	4	1	LS55 VZV A4+2	1	1,21

Ein-Aus-Schalter, Reiheneinbau, Schutzart IP40, Typ 1



DDC21B / DC-PV1 600V DC 1000V DC	Anzahl Pole in Serie	Anzahl Strings	Typ	VPE Stk.	Gewicht kg/Stk.
16A 10A	2	1	LS16 SMA A2	1	0,19
25A 11,5A	2	1	LS25 SMA A2	1	0,19
32A 13A	2	1	LS32 SMA A2	1	0,19
40A 29A	2	1	LS40 SMA A2	1	0,41
55A 36A	2	1	LS55 SMA A2	1	0,41

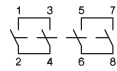

29A 10A	2	1	LS16 SMA A2+2	1	0,24
36A 11,5A	2	1	LS25 SMA A2+2	1	0,24
55A 13A	2	1	LS32 SMA A2+2	1	0,24
68A 29A	2	1	LS40 SMA A2+2	1	0,52
85A 36A	2	1	LS55 SMA A2+2	1	0,52

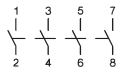

16A 10A	2	2	LS16 SMA A4	1	0,22
25A 11,5A	2	2	LS25 SMA A4	1	0,22
32A 13A	2	2	LS32 SMA A4	1	0,22
40A 29A	2	2	LS40 SMA A4	1	0,45
55A 36A	2	2	LS55 SMA A4	1	0,45

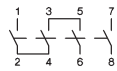

16A 16A	4	1	LS16 SMA A4B	1	0,23
25A 25A	4	1	LS25 SMA A4B	1	0,23
32A 32A	4	1	LS32 SMA A4B	1	0,23
40A 40A	4	1	LS40 SMA A4B	1	0,49
55A 55A	4	1	LS55 SMA A4B	1	0,49

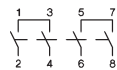

16A 16A	4	1	LS16 SMA A4O	1	0,23
25A 25A	4	1	LS25 SMA A4O	1	0,23
32A 32A	4	1	LS32 SMA A4O	1	0,23
40A 40A	4	1	LS40 SMA A4O	1	0,49
55A 55A	4	1	LS55 SMA A4O	1	0,49

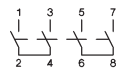

16A 16A	4	1	LS16 SMA A4U	1	0,23
25A 25A	4	1	LS25 SMA A4U	1	0,23
32A 32A	4	1	LS32 SMA A4U	1	0,23
40A 40A	4	1	LS40 SMA A4U	1	0,49
55A 55A	4	1	LS55 SMA A4U	1	0,49

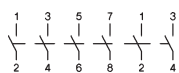

16A 10A	2	3	LS16 SMA A6	1	0,35
25A 11,5A	2	3	LS25 SMA A6	1	0,35
32A 13A	2	3	LS32 SMA A6	1	0,35
40A 29A	2	3	LS40 SMA A6	1	0,89
55A 36A	2	3	LS55 SMA A6	1	0,89

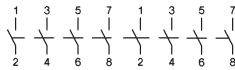

16A 10A	2	4	LS16 SMA A8	1	0,40
25A 11,5A	2	4	LS25 SMA A8	1	0,40
32A 13A	2	4	LS32 SMA A8	1	0,40
40A 29A	2	4	LS40 SMA A8	1	0,99
55A 36A	2	4	LS55 SMA A8	1	0,99

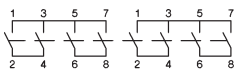

29A 29A	4	1	LS16 SMA A4+2	1	0,43
45A 45A	4	1	LS25 SMA A4+2	1	0,43
58A 58A	4	1	LS32 SMA A4+2	1	0,43
72A 72A	4	1	LS40 SMA A4+2	1	1,01
85A 85A	4	1	LS55 SMA A4+2	1	1,01

Hauptschalter, Fronteinbau m. Vierlochbefestigung, Schild 64³, Schutzart IP66, Typ 4X



DC21B / DC-PV1 600V DC 1000V DC	Anzahl Pole in Serie	Anzahl Strings	Typ	VPE Stk.	Gewicht kg/Stk.
16A 10A	2	1	LS16 EH4 A2	1	0,21
25A 11,5A	2	1	LS25 EH4 A2	1	0,21
32A 13A	2	1	LS32 EH4 A2	1	0,21
40A 29A	2	1	LS40 EH4 A2	1	0,43
55A 36A	2	1	LS55 EH4 A2	1	0,43

Sperrvorrichtung SV4

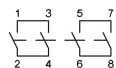

29A 10A	2	1	LS16 EH4 A2+2	1	0,26
36A 11,5A	2	1	LS25 EH4 A2+2	1	0,26
55A 13A	2	1	LS32 EH4 A2+2	1	0,26
68A 29A	2	1	LS40 EH4 A2+2	1	0,57
85A 36A	2	1	LS55 EH4 A2+2	1	0,57

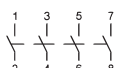

16A 10A	2	2	LS16 EH4 A4	1	0,24
25A 11,5A	2	2	LS25 EH4 A4	1	0,24
32A 13A	2	2	LS32 EH4 A4	1	0,24
40A 29A	2	2	LS40 EH4 A4	1	0,50
55A 36A	2	2	LS55 EH4 A4	1	0,50

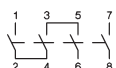

16A 16A	4	1	LS16 EH4 A4B	1	0,25
25A 25A	4	1	LS25 EH4 A4B	1	0,25
32A 32A	4	1	LS32 EH4 A4B	1	0,25
40A 40A	4	1	LS40 EH4 A4B	1	0,53
55A 55A	4	1	LS55 EH4 A4B	1	0,53

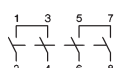

16A 16A	4	1	LS16 EH4 A4O	1	0,25
25A 25A	4	1	LS25 EH4 A4O	1	0,25
32A 32A	4	1	LS32 EH4 A4O	1	0,25
40A 40A	4	1	LS40 EH4 A4O	1	0,53
55A 55A	4	1	LS55 EH4 A4O	1	0,53

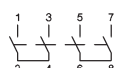

16A 16A	4	1	LS16 EH4 A4U	1	0,25
25A 25A	4	1	LS25 EH4 A4U	1	0,25
32A 32A	4	1	LS32 EH4 A4U	1	0,25
40A 40A	4	1	LS40 EH4 A4U	1	0,53
55A 55A	4	1	LS55 EH4 A4U	1	0,53

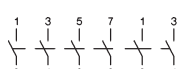

16A 10A	2	3	LS16 EH4 A6	1	0,37
25A 11,5A	2	3	LS25 EH4 A6	1	0,37
32A 13A	2	3	LS32 EH4 A6	1	0,37
40A 29A	2	3	LS40 EH4 A6	1	0,53
55A 36A	2	3	LS55 EH4 A6	1	0,53

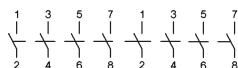

16A 10A	2	4	LS16 EH4 A8	1	0,42
25A 11,5A	2	4	LS25 EH4 A8	1	0,42
32A 13A	2	4	LS32 EH4 A8	1	0,42
40A 29A	2	4	LS40 EH4 A8	1	1,10
55A 36A	2	4	LS55 EH4 A8	1	1,10

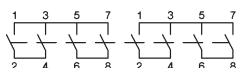

29A 29A	4	1	LS16 EH4 A4+2	1	0,47
45A 45A	4	1	LS25 EH4 A4+2	1	0,47
58A 58A	4	1	LS32 EH4 A4+2	1	0,47
72A 72A	4	1	LS40 EH4 A4+2	1	1,21
85A 85A	4	1	LS55 EH4 A4+2	1	1,21

Verlängerte Schalterwelle für Schalter für Fronteinbau

Typenzusatz

+VW“x“

x = Paneelstärke

Hauptschalter, Zentralbefestigung Ø22mm, Schild 48[°], Schutzart IP66, Typ 4X



DC21B / DC-PV1 600V DC	DC 1000V DC	Anzahl Pole in Serie	Anzahl Strings	Typ	VPE Stk.	Gewicht kg/Stk.
16A	10A	2	1	LS16 ZH1 A2	1	0,21
25A	11,5A	2	1	LS25 ZH1 A2	1	0,21
32A	13A	2	1	LS32 ZH1 A2	1	0,21

Sperrvorrichtung SV1

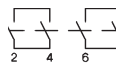

29A	10A	2	1	LS16 ZH1 A2+2	1	0,27
36A	11,5A	2	1	LS25 ZH1 A2+2	1	0,27
55A	13A	2	1	LS32 ZH1 A2+2	1	0,27

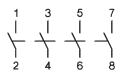

16A	10A	2	2	LS16 ZH1 A4	1	0,24
25A	11,5A	2	2	LS25 ZH1 A4	1	0,24
32A	13A	2	2	LS32 ZH1 A4	1	0,24

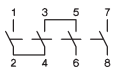

16A	16A	4	1	LS16 ZH1 A4B	1	0,25
25A	25A	4	1	LS25 ZH1 A4B	1	0,25
32A	32A	4	1	LS32 ZH1 A4B	1	0,25

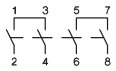

16A	16A	4	1	LS16 ZH1 A4O	1	0,25
25A	25A	4	1	LS25 ZH1 A4O	1	0,25
32A	32A	4	1	LS32 ZH1 A4O	1	0,25

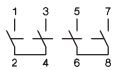

16A	16A	4	1	LS16 ZH1 A4U	1	0,25
25A	25A	4	1	LS25 ZH1 A4U	1	0,25
32A	32A	4	1	LS32 ZH1 A4U	1	0,25

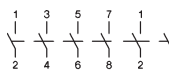

16A	10A	2	3	LS16 ZH1 A6	1	0,39
25A	11,5A	2	3	LS25 ZH1 A6	1	0,39
32A	13A	2	3	LS32 ZH1 A6	1	0,39

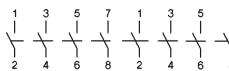

16A	10A	2	4	LS16 ZH1 A8	1	0,44
25A	11,5A	2	4	LS25 ZH1 A8	1	0,44
32A	13A	2	4	LS32 ZH1 A8	1	0,44

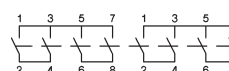

29A	29A	4	1	LS16 ZH1 A4+2	1	0,49
45A	45A	4	1	LS25 ZH1 A4+2	1	0,49
58A	58A	4	1	LS32 ZH1 A4+2	1	0,49

Hauptschalter, Zentralbefestigung Ø22mm, ohne Schild, Schutzart IP66, Typ 3R

bei Type „ZH1“ durch „ZOH1“ ersetzen **LS.. ZOH1 A.**

Hauptschalter, Bodenmontage, Türkupplung für Zentralbefestigung, Schild 64³, Schutzart IP66,



DC21B / DC-PV1 600V DC 1000V DC	Anzahl Pole in Serie	Anzahl Strings	Typ	VPE Stk.	Gewicht kg/Stk.
16A 10A	2	1	LS16 VZVH4 A2	1	0,23
25A 11,5A	2	1	LS25 VZVH4 A2	1	0,23
32A 13A	2	1	LS32 VZVH4 A2	1	0,23
40A 29A	2	1	LS40 VZVH4 A2	1	0,51
55A 36A	2	1	LS55 VZVH4 A2	1	0,51

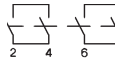

29A 10A	2	1	LS16 VZVH4 A2+2	1	0,28
36A 11,5A	2	1	LS25 VZVH4 A2+2	1	0,28
55A 13A	2	1	LS32 VZVH4 A2+2	1	0,28
68A 29A	2	1	LS40 VZVH4 A2+2	1	0,65
85A 36A	2	1	LS55 VZVH4 A2+2	1	0,65

Einbautiefe einstellbar

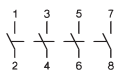

16A 10A	2	2	LS16 VZVH4 A4	1	0,26
25A 11,5A	2	2	LS25 VZVH4 A4	1	0,26
32A 13A	2	2	LS32 VZVH4 A4	1	0,26
40A 29A	2	2	LS40 VZVH4 A4	1	0,58
55A 36A	2	2	LS55 VZVH4 A4	1	0,58

Sperrvorrichtung SV4

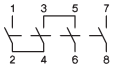

16A 16A	4	1	LS16 VZVH4 A4B	1	0,27
25A 25A	4	1	LS25 VZVH4 A4B	1	0,27
32A 32A	4	1	LS32 VZVH4 A4B	1	0,27
40A 40A	4	1	LS40 VZVH4 A4B	1	0,62
55A 55A	4	1	LS55 VZVH4 A4B	1	0,62

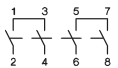

16A 16A	4	1	LS16 VZVH4 A4O	1	0,27
25A 25A	4	1	LS25 VZVH4 A4O	1	0,27
32A 32A	4	1	LS32 VZVH4 A4O	1	0,27
40A 40A	4	1	LS40 VZVH4 A4O	1	0,62
55A 55A	4	1	LS55 VZVH4 A4O	1	0,62

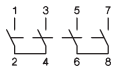

16A 16A	4	1	LS16 VZVH4 A4U	1	0,27
25A 25A	4	1	LS25 VZVH4 A4U	1	0,27
32A 32A	4	1	LS32 VZVH4 A4U	1	0,27
40A 40A	4	1	LS40 VZVH4 A4U	1	0,62
55A 55A	4	1	LS55 VZVH4 A4U	1	0,62

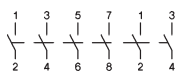

16A 10A	2	3	LS16 VZVH4 A6	1	0,39
25A 11,5A	2	3	LS25 VZVH4 A6	1	0,39
32A 13A	2	3	LS32 VZVH4 A6	1	0,39
40A 29A	2	3	LS40 VZVH4 A6	1	1,00
55A 36A	2	3	LS55 VZVH4 A6	1	1,00

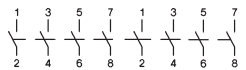

16A 10A	2	4	LS16 VZVH4 A8	1	0,44
25A 11,5A	2	4	LS25 VZVH4 A8	1	0,44
32A 13A	2	4	LS32 VZVH4 A8	1	0,44
40A 29A	2	4	LS40 VZVH4 A8	1	1,11
55A 36A	2	4	LS55 VZVH4 A8	1	1,11

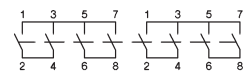

29A 29A	4	1	LS16 VZVH4 A4+2	1	0,49
45A 45A	4	1	LS25 VZVH4 A4+2	1	0,49
58A 58A	4	1	LS32 VZVH4 A4+2	1	0,49
72A 72A	4	1	LS40 VZVH4 A4+2	1	1,22
85A 85A	4	1	LS55 VZVH4 A4+2	1	1,22

Hauptschalter, Reiheneinbau, versperrbar, Schutzart IP40, US Typ 1



DC21B / DC-PV1 600V DC 1000V DC	Anzahl Pole in Serie	Anzahl Strings	Typ	VPE Stk.	Gewicht kg/Stk.
16A 10A	2	1	LS16 SMAH1 A2	1	0,19
25A 11,5A	2	1	LS25 SMAH1 A2	1	0,19
32A 13A	2	1	LS32 SMAH1 A2	1	0,19
40A 29A	2	1	LS40 SMAH1 A2	1	0,40
55A 36A	2	1	LS55 SMAH1 A2	1	0,40

Sperrvorrichtung SV1

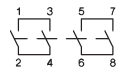

29A 10A	2	1	LS16 SMAH1 A2+2 ¹⁾	1	0,25
36A 11,5A	2	1	LS25 SMAH1 A2+2 ¹⁾	1	0,25
55A 13A	2	1	LS32 SMAH1 A2+2 ¹⁾	1	0,25
68A 29A	2	1	LS40 SMAH1 A2+2	1	0,54
85A 36A	2	1	LS55 SMAH1 A2+2	1	0,54

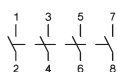

16A 10A	2	2	LS16 SMAH1 A4 ¹⁾	1	0,22
25A 11,5A	2	2	LS25 SMAH1 A4 ¹⁾	1	0,22
32A 13A	2	2	LS32 SMAH1 A4 ¹⁾	1	0,22
40A 29A	2	2	LS40 SMAH1 A4	1	0,47
55A 36A	2	2	LS55 SMAH1 A4	1	0,47

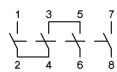

16A 16A	4	1	LS16 SMAH1 A4B ¹⁾	1	0,23
25A 25A	4	1	LS25 SMAH1 A4B ¹⁾	1	0,23
32A 32A	4	1	LS32 SMAH1 A4B ¹⁾	1	0,23
40A 40A	4	1	LS40 SMAH1 A4B	1	0,50
55A 55A	4	1	LS55 SMAH1 A4B	1	0,50

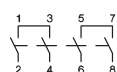

16A 16A	4	1	LS16 SMAH1 A4O ¹⁾	1	0,23
25A 25A	4	1	LS25 SMAH1 A4O ¹⁾	1	0,23
32A 32A	4	1	LS32 SMAH1 A4O ¹⁾	1	0,23
40A 40A	4	1	LS40 SMAH1 A4B	1	0,50
55A 55A	4	1	LS55 SMAH1 A4B	1	0,50

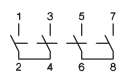

16A 16A	4	1	LS16 SMAH1 A4U ¹⁾	1	0,23
25A 25A	4	1	LS25 SMAH1 A4U ¹⁾	1	0,23
32A 32A	4	1	LS32 SMAH1 A4U ¹⁾	1	0,23
40A 40A	4	1	LS40 SMAH1 A4B	1	0,50
55A 55A	4	1	LS55 SMAH1 A4B	1	0,50

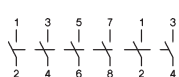

16A 10A	2	3	LS16 SMAH1 A6	1	0,36
25A 11,5A	2	3	LS25 SMAH1 A6	1	0,36
32A 13A	2	3	LS32 SMAH1 A6	1	0,36
40A 29A	2	3	LS40 SMAH1 A6	1	0,90
55A 36A	2	3	LS55 SMAH1 A6	1	0,90

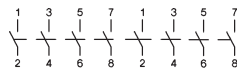

16A 10A	2	4	LS16 SMAH1 A8	1	0,41
25A 11,5A	2	4	LS25 SMAH1 A8	1	0,41
32A 13A	2	4	LS32 SMAH1 A8	1	0,41
40A 29A	2	4	LS40 SMAH1 A8	1	0,41
55A 36A	2	4	LS32 SMAH1 A8	1	0,41

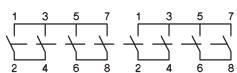

29A 29A	4	1	LS16 SMAH1 A4+2	1	0,46
45A 45A	4	1	LS25 SMAH1 A4+2	1	0,46
58A 58A	4	1	LS32 SMAH1 A4+2	1	0,46
72A 72A	4	1	LS40 SMAH1 A4+2	1	1,12
85A 85A	4	1	LS55 SMAH1 A4+2	1	1,12

¹⁾ Hauptschalter, Reiheneinbau mit niedrigem Griff, versperrbar, Schutzart IP40,   US Typ 1

Typ mit Typenzusatz „+SV1N“ z.B.: **LS.. SMAH1 A2+2 +SV1N**

Hauptschalter, isolierstoffgekapstelt, Schild 64³, Schutzart IP66,



Sperrvorrichtung SV4



DC21B / DC-PV1 600V DC	1000V DC	Anzahl Pole in Serie	Anzahl Strings	Typ	VPE Stk.	Gewicht kg/Stk.
16A	10A	2	1	LS16 PFLH4 A2 ¹⁾	1	0,43
25A	11,5A	2	1	LS25 PFLH4 A2 ¹⁾	1	0,43
32A	13A	2	1	LS32 PFLH4 A2 ¹⁾	1	0,43
40A	29A	2	1	LS40 PFLH4 A2	1	1,59
55A	36A	2	1	LS55 PFLH4 A2	1	1,59

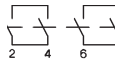

29A	10A	2	1	LS16 PFLH4 A2+2 ¹⁾	1	0,49
36A	11,5A	2	1	LS25 PFLH4 A2+2 ¹⁾	1	0,49
55A	13A	2	1	LS32 PFLH4 A2+2 ¹⁾	1	0,49
68A	29A	2	1	LS40 PFLH4 A2+2	1	1,74
85A	36A	2	1	LS55 PFLH4 A2+2	1	1,74

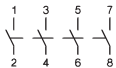

16A	10A	2	2	LS16 PFLH4 A4 ¹⁾	1	0,46
25A	11,5A	2	2	LS25 PFLH4 A4 ¹⁾	1	0,46
32A	13A	2	2	LS32 PFLH4 A4 ¹⁾	1	0,46
40A	29A	2	2	LS40 PFLH4 A4	1	1,67
55A	36A	2	2	LS55 PFLH4 A4	1	1,67

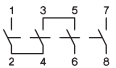

16A	16A	4	1	LS16 PFLH4 A4B ¹⁾	1	0,47
25A	25A	4	1	LS25 PFLH4 A4B ¹⁾	1	0,47
32A	32A	4	1	LS32 PFLH4 A4B ¹⁾	1	0,47
40A	40A	4	1	LS40 PFLH4 A4B	1	1,70
55A	55A	4	1	LS55 PFLH4 A4B	1	1,70

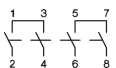

16A	16A	4	1	LS16 PFLH4 A4O ¹⁾	1	0,47
25A	25A	4	1	LS25 PFLH4 A4O ¹⁾	1	0,47
32A	32A	4	1	LS32 PFLH4 A4O ¹⁾	1	0,47
40A	40A	4	1	LS40 PFLH4 A4O	1	1,70
55A	55A	4	1	LS55 PFLH4 A4O	1	1,70

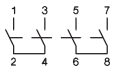

16A	16A	4	1	LS16 PFLH4 A4U ¹⁾	1	0,47
25A	25A	4	1	LS25 PFLH4 A4U ¹⁾	1	0,47
32A	32A	4	1	LS32 PFLH4 A4U ¹⁾	1	0,47
40A	40A	4	1	LS40 PFLH4 A4U	1	1,70
55A	55A	4	1	LS55 PFLH4 A4U	1	1,70

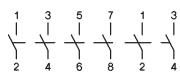

16A	10A	2	3	LS16 PFLH4 A6	1	1,53
25A	11,5A	2	3	LS25 PFLH4 A6	1	1,53
32A	13A	2	3	LS32 PFLH4 A6	1	1,53
40A	29A	2	3	LS40 PFLH4 A6	1	1,87
55A	36A	2	3	LS55 PFLH4 A6	1	1,87

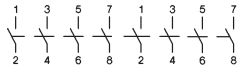

16A	10A	2	4	LS16 PFLH4 A8	1	1,58
25A	11,5A	2	4	LS25 PFLH4 A8	1	1,58
32A	13A	2	4	LS32 PFLH4 A8	1	1,58
40A	29A	2	4	LS40 PFLH4 A8	1	1,94
55A	36A	2	4	LS55 PFLH4 A8	1	1,94

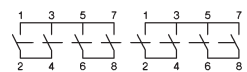

29A	29A	4	1	LS16 PFLH4 A4+2	1	1,63
45A	45A	4	1	LS25 PFLH4 A4+2	1	1,63
58A	58A	4	1	LS32 PFLH4 A4+2	1	1,63
72A	72A	4	1	LS40 PFLH4 A4+2	1	2,07
85A	85A	4	1	LS55 PFLH4 A4+2	1	2,07

Technische Daten

Strom-art	Gebrauchskategorie		Typische Anwendungsfälle	Prüfungsbedingungen für Elektrische Lebensdauer (Normale Beanspruchung)						Prüfungsbedingungen für Ein- und Ausschaltvermögen (Beanspruchung im Störfall)					
				Einschalten			Ausschalten			Einschalten			Ausschalten		
				I/le	U/Ue	L/R	Ic/le	Ur/Ue	L/R	I/le	U/Ue	L/R	Ic/le	Ur/Ue	L/R
Gleich-Strom	DC21A häufige Betätigung	DC21B gelegentl. Betätigung	Schalten von ohmscher Last einschließlich geringer Überlast.	1	1	1ms	1	1	1ms	1,5	1,05	1ms	1,5	1,05	1ms
	DC22A häufige Betätigung	DC22B gelegentl. Betätigung	Schalten von gemischter ohmscher und induktiver Last einschließlich geringer Überlast.	1	1	2ms	1	1	2ms	4	1,05	2,5ms	4	1,05	2,5ms
	DC-PV1		Schalten eines einzelnen PV String(s) ohne Rück- und Überströme.	1	1	1ms	1	1	1ms	1,5	1,05	1ms	1,5	1,05	1ms
	DC-PV2		Schalten von mehreren PV Strings mit Rück- und Überströmen.	1	1	1ms	1	1	1ms	4	1,05	1ms	4	1,05	1ms

Daten nach IEC 60947-3, VDE 0660, GB14048.3 (CCC) China)



Hauptkontakte		Typ	LS16	LS25	LS32	LS40	LS55		
Thermischer Bemessungsbetriebsstrom I_{th}		A	16	25	32	40	55		
Bemessungsisolationsspannung U_i ¹⁾		V	1000	1000	1000	1500	1500		
Bemessungsisolationsspannung U_i ²⁾		V	1500	1500	1500	1500	1500		
Kontaktabstand (pro Pol)		mm	8	8	8				
Bemessungsbetriebsstrom I_e	300V	A	16	23	27	40	55		
	400V	A	12	14	16	30	40		
DC21A und DC21B	A1	A	9	11	13	19	25		
		A	600V	8	10	15	20		
DC21B		A	700V	4,5	6	7,5	10		
		A	800V	3	4	5	8		
		A	900V	2,5	3	4	6		
		A	1000V	1,5	2	2,5	4		
		2 Pole in Serie A2	A	500V	16	25	32	40	55
			A	600V	16	25	32	40	55
	A		700V	16	23	27	35	55	
	A		800V	16	20	21	30	45	
	A		850V	18	22	25	-	-	
	A		900V	13	16	18	25	35	
		A	1000V	9	11	13	20	36	
		A	1200V	6	8	10	10	15	
A		1500V	3	4	5	6	7,5		
2 Pole in Serie + 2 Pole parallel A2+2		A	500V	29	45	58	72	85	
		A	600V	29	45	50	64	80	
		A	700V	16	23	27	35	55	
	A	800V	16	20	21	30	45		
	A	900V	13	16	18	25	35		
	A	1000V	9	11	13	20	25		
	A	1200V	6	8	10	10	15		
	A	1500V	3	4	5	6	7,5		
	3 Pole in Serie + 2 Pole parallel A3+2	A	500V	29	45	58	72	85	
A		600V	29	45	50	72	85		
A		700V	29	38	45	72	85		
A		800V	29	38	45	68	85		
A		900V	29	38	45	62	78		
A		1000V	29	38	45	58	70		
4 Pole in Serie A4	A	1200V	12	14	16	-	-		
	A	1500V	9	11	13	-	-		
	A	500V	16	25	32	40	55		
	A	600V	16	25	32	40	55		
	A	700V	16	25	32	40	55		
	A	800V	16	25	32	40	55		
	A	900V	16	25	32	40	55		
	A	1000V	16	25	32	40	55		
	A	1200V	16	25	32	40	55		
	A	1500V	16	20	23	30	40		
	4 Pole in Serie + 2 Pole parallel A4+2	A	500V	29	45	58	72	85	
		A	600V	29	45	58	72	85	
A		700V	29	45	58	72	85		
	A	800V	29	45	58	72	85		
	A	900V	29	45	58	72	85		
	A	1000V	29	45	58	72	85		
	A	1200V	29	45	50	56	65		
A	1500V	16	20	23	42	55			
Bemessungsbetriebsstrom I_e AC21B	A2, A4	U_e max. 440V	A	16	25	32	40	55	
	A2+2	U_e max. 440V	A	29	45	58	72	85	

1) Gilt für: Überspannungskategorie I bis III, Verschmutzungsgrad 3 (Norm-Industrie): $U_{imp} = 8kV$.

2) Gilt für: Überspannungskategorie I bis III, Verschmutzungsgrad 2 (min. IP55): $U_{imp} = 8kV$.

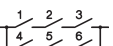
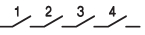
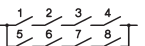

Technische Daten

Daten nach IEC 60947-3, VDE 0660

Hauptkontakte		Type	LS16	LS25	LS32	LS40	LS55	
Bemessungsbetriebsstrom I_e DC-PV1	1 Pol	300V	A	16	23	27	40	55
		400V	A	14	22	25	33	44
	A1 	500V	A	10	17	20	24	32
		600V	A	7	12	15	19	25
		700V	A	5	6	7	12	18
		800V	A	3	4	5	10	13
		900V	A	3	3	4	8	10
		1000V	A	2	2	3	5	8
	2 Pole in Serie A2 	500V	A	16	25	32	40	55
		600V	A	16	25	32	40	55
		700V	A	16	25	32	37	55
		800V	A	16	19	21	35	55
		900V	A	16	17	18	31	43
		1000V	A	10	11,5	13	29	36
		1100V	A	8	10	11,5	19	25
1200V		A	7	8,5	10	11	17	
1300V		A	6	7	8	10	14	
1400V		A	5	6	7	9	12	
1500V	A	3	5	6	7,5	10		
2 Pole in Serie + 2 Pole parallel A2+2 	500V	A	29	45	58	72	85	
	600V	A	29	36	55	68	85	
	700V	A	22	27	32	49	77	
	800V	A	17	19	21	42	63	
	900V	A	16	17	18	31	43	
	1000V	A	10	11,5	13	29	36	
	1100V	A	8	10	11,5	19	25	
	1200V	A	7	8,5	10	11	17	
	1300V	A	6	7	8	10	14	
	1400V	A	5	6	7	9	12	
1500V	A	3	5	6	7,5	10		
3 Pole in Serie + 2 Pole parallel A3+2 	500V	A	29	45	58	72	85	
	600V	A	29	45	58	72	85	
	700V	A	29	43	55	72	85	
	800V	A	29	40	51	68	85	
	900V	A	29	38	47	62	78	
	1000V	A	29	38	45	58	70	
	1100V	A	19	27	37	-	-	
	1200V	A	17	25	28	-	-	
	1300V	A	15	21	25	-	-	
	1400V	A	12	18	22	-	-	
1500V	A	10	14	20	-	-		
4 Pole in Serie A4 	500V	A	16	25	32	40	55	
	600V	A	16	25	32	40	55	
	700V	A	16	25	32	40	55	
	800V	A	16	25	32	40	55	
	900V	A	16	25	32	40	55	
	1000V	A	16	25	32	40	55	
	1100V	A	16	25	32	40	55	
	1200V	A	16	25	32	40	55	
	1300V	A	16	25	32	40	55	
	1400V	A	16	25	32	40	55	
1500V	A	16	25	32	40	55		
4 Pole in Serie + 2 Pole parallel A4+2 	500V	A	29	45	58	72	85	
	600V	A	29	45	58	72	85	
	700V	A	29	45	58	72	85	
	800V	A	29	45	58	72	85	
	900V	A	29	45	58	72	85	
	1000V	A	29	45	58	72	85	
	1100V	A	29	45	54	60	68	
	1200V	A	29	45	50	56	65	
	1300V	A	26	39	44	50	61	
	1400V	A	23	33	38	46	58	
1500V	A	20	26	32	42	55		

Technische Daten

Daten nach IEC 60947-3, VDE 0660

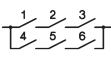
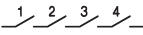
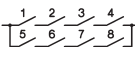
Hauptkontakte		Type	LS16	LS25	LS32	LS40	LS55	
Bemessungsbetriebsstrom I_e DC-PV2	300V	A	16	23	27	40	55	
	400V	A	15	18	20	30	40	
1 pole A1 	500V	A	10	12	14	19	25	
	600V	A	5	6	8	10	13	
	700V	A	1,5	2	3	7	10	
	800V	A	1,5	2	3	6	8	
	900V	A	1	1,5	2,0	5	6	
	1000V	A	1	1,5	2,0	3	4	
	2 poles in series A2 	500V	A	16	25	32	40	55
		600V	A	14	21	27	40	55
700V		A	13	19	22	35	55	
800V		A	12	15	17	33	49	
900V		A	8	10	12	25	35	
1000V		A	4	5	6	16	20	
1100V		A	83	4	5	11	15	
1200V		A	2	3	4	8	12	
1300V		A	1,5	2	3	7	10	
1400V		A	1	2	3	7	9	
1500V	A	1	1,5	2	6	8		
2 poles in series + 2 poles parallel A2+2 	500V	A	25	39	50	72	85	
	600V	A	20	32	35	60	75	
	700V	A	13	19	22	38	60	
	800V	A	12	15	17	33	49	
	900V	A	8	10	12	25	35	
	1000V	A	4	5	6	16	25	
	1100V	A	3	4	5	10	15	
	1200V	A	2	3	4	8	12	
	1300V	A	1,5	2	3	7	10	
	1400V	A	1	2	3	7	9	
1500V	A	1	1,5	2	6	8		
3 poles in series + 2 poles parallel A3+2 	500V	A	-	-	-	72	85	
	600V	A	-	-	-	72	78	
	700V	A	-	-	-	62	69	
	800V	A	-	-	-	53	61	
	900V	A	-	-	-	44	55	
	1000V	A	-	-	-	35	50	
	1100V	A	-	-	-	-	-	
	1200V	A	-	-	-	-	-	
	1300V	A	-	-	-	-	-	
	1400V	A	-	-	-	-	-	
1500V	A	-	-	-	-	-		
4 poles in series A4 	500V	A	16	25	32	40	55	
	600V	A	16	25	32	40	55	
	700V	A	16	25	32	40	55	
	800V	A	16	25	32	40	55	
	900V	A	16	25	32	40	55	
	1000V	A	16	25	32	40	55	
	1100V	A	15	25	32	40	55	
	1200V	A	13,5	21	27	40	55	
	1300V	A	12	19	24	36	50	
	1400V	A	10,5	16	21	33	45	
1500V	A	9	14	18	30	40		
4 poles in series + 2 poles parallel A4+2 	500V	A	-	-	-	72	85	
	600V	A	-	-	-	72	85	
	700V	A	-	-	-	72	80	
	800V	A	-	-	-	67	75	
	900V	A	-	-	-	59	70	
	1000V	A	-	-	-	52	64	
	1100V	A	-	-	-	44	59	
	1200V	A	-	-	-	40	55	
	1300V	A	-	-	-	36	50	
	1400V	A	-	-	-	33	45	
1500V	A	-	-	-	30	40		

Schütze, Motorstarter

Leistungsschalter

Motorschutzschalter

Schalter

AC-Hauptschalter





DC-Lasttrennschalter

Behalts- und Meldergeräte

Verteilungen, Bezugsquellen

Technische Daten







Daten nach IEC 60947-3, VDE 0660

Hauptkontakte			Typ	LS16	LS25	LS32	LS40	LS55
Bemessungsbetriebsstrom I_e DC22B	1 Pol A1 	500V	A	1	1,25	1,5	x	2,5
		600V	A	0,5	0,75	1	x	2,0
		800V	A	0,3	0,4	0,5	x	1,5
		1000V	A	0,15	0,2	0,25	x	1,0
		1200V	A	-	-	-	x	x
		1500V	A	-	-	-	x	x
		2 Pole in Serie A2	A	7	8	9	x	x
		600V	A	5,5	6	6,5	x	x
		800V	A	2	2,5	3	x	x
		1000V	A	1	1,5	2	x	x
		1200V	A	-	-	-	x	x
		1500V	A	-	-	-	x	x
		4 Pole in Serie A4	A	16	25	32	x	x
		600V	A	16	25	27,5	x	x
		800V	A	11,5	12	12,5	x	x
1000V		A	8	9	10	x	x	
1200V		A	-	-	-	x	x	
1500V		A	-	-	-	x	x	
Bedingter Bemessungskurzschlußstrom			kA _{eff}	5	5	5	10	10
Maximale Vorsicherung			gL (gG)	40	63	80	125	160
Mechanische Lebensdauer			x10 ³	10	10	10	10	10
Bemessungskurzzeit- stromfestigkeit (1s)	I _{cw}	A2, A4, A6, A8	A	800	900	1000	A2, A4: 1200	A2, A4: 1400
		A2+2, A3+2, A4+2	A	1300	1500	1700	A2+2: 2000	A2+2: 2400
Bemessungskurzschluß- einschaltvermögen	I _{cm}	A2, A4, A6, A8	A	800	900	1000	A2, A4: 1200	A2, A4: 1400
		A2+2, A3+2, A4+2	A	1300	1500	1700	A2+2: 2000	A2+2: 2400
Anschlußquerschnitte (inkl. Verbinder)				LSV-B1	LSV-B1	LSV-B1	LSV-B2	LSV-B2
ein- oder mehrdrähtig			mm ²	4 - 16	4 - 16	4 - 16	2,5 - 25	2,5 - 25
feindrähtig			mm ²	4 - 10	4 - 10	4 - 10	2,5 - 16	2,5 - 16
feindrähtig (+ Aderendhülse)			mm ²	4 - 10	4 - 10	4 - 10	1,5 - 16	1,5 - 16
Klemmschraube				M4 Pz2	M4 Pz2	M4 Pz2	M5 Pz2	M5 Pz2
Anzugsdrehmoment			Nm	1,7 - 1,8	1,7 - 1,8	1,7 - 1,8	2,5 - 2,8	2,5 - 2,8
2 Leiter pro Klemme ohne Verbinder LSV-B1 / LSV-B2								
ein- oder mehrdrähtig			mm ²	16+(1,5-2,5) / 10+(1,5-6) / 6+(1,5-10) / 4+(1,5-10)			16+(1,5-2,5) / 10+(1,5-10) / 6+(1,5-10) / 4+(1,5-10)	
feindrähtig & feindrähtig + Aderendhülse			mm ²	16+(1,5-2,5) / 10+(1,5-4) / 6+(1,5-6)			16+(1,5-6) / 10+(1,5-10) / 6+(1,5-16) / 4+(1,5-16)	
stranded			AWG	8+(16-12) / 10+(16-10) / 12+(16-8) 14+(16-8)			3+(18-10) / 4+(18-10) / 6+(18-8) 8+(18-8)	
solid			AWG	10+(16-12) / 12+(16-10) 14+(16-10)			10+(16-10) / 12+(16-10) / 14+(16-10) 12+(16-10) / 14+(16-10)	
Zulässige Umgebungstemperatur								
Betrieb	offen	°C	-40 to +65					
	gekapselt	°C	-40 to +45					
Lagerung		°C	-50 to +90					
Verlustleistung pro Schalter bei I _e max.				A	A	A	A	A
A2	(A)/ W	(16)/ 1	(25)/ 2,3	(32)/ 3,7	(40)/ 4	(55)/ 7,5		
A4	(A)/ W	(16)/ 2	(25)/ 4,6	(32)/ 7,4	(40)/ 8	(55)/ 15		
A6	(A)/ W	(16)/ 3	(25)/ 6,9	(32)/ 11,1	(40)/ 12	(55)/ 22,5		
A8	(A)/ W	(16)/ 4	(25)/ 9,2	(32)/ 14,8	(40)/ 16	(55)/ 30		
A2+2	(A)/ W	(29)/ 1,5	(45)/ 3,7	(58)/ 6	(72)/ 6,5	(85)/ 9		
A3+2	(A)/ W	(29)/ 2,3	(45)/ 5,6	(58)/ 9	(72)/ 9,8	(85)/ 14		
A4+2	(A)/ W	(29)/ 3	(45)/ 7,4	(58)/ 12	(72)/ 13	(85)/ 18		
Kontaktwiderstand pro Pol			mΩ	1,75	1,75	1,75	1,25	1,25

x zur Approbation eingereicht

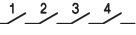
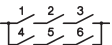
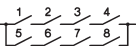





Technische Daten

Daten nach UL508I  File E359344 Category np.: NMSJ, und UL508  File E332938, Category no.: NRNT2, NRNT8

Typ			LS16	LS25	LS32	LS40	LS55
Ampere-Rating "General use"	1 Pol 	DC					
		350V A	4	5	6	7,1	10,0
		500V A	4	5	6	5,7	7,0
		600V A	4	5	6	5,0	5,8
		700V A	-	-	-	3,9	5,0
		800V A	-	-	-	3,2	4,4
		900V A	-	-	-	2,5	3,5
	1000V A	-	-	-	1,5	2,0	
	2 Pole in Serie A2 	350V A	16	25	32	40	55
		500V A	16	25	32	40	55
		600V A	16	25	32	40	55
		700V A	-	-	-	32	46
		800V A	-	-	-	26	37
		900V A	-	-	-	20	28
1000V A		-	-	-	16	20	
2 Pole in Serie + 2 Pole parallel A2+2 	350V A	29	45	58	72	85	
	400V A	-	-	-	67	79	
	500V A	29	38	40	53	66	
	600V A	21	25	32	42	55	
	700V A	-	-	-	35	47	
	800V A	-	-	-	30	40	
	900V A	-	-	-	26	32	
1000V A	-	-	-	22	25		
4 Pole in Serie A4 	350V A	16	25	32	40	55	
	500V A	16	25	32	40	55	
	600V A	16	25	32	40	55	
	700V A	-	-	-	40	55	
	800V A	-	-	-	40	55	
	900V A	-	-	-	40	55	
	1000V A	-	-	-	40	55	
3 Pole in Serie + 2 Pole parallel A3+2 	350V A	29	45	58	68	71	
	500V A	29	38	50	56	64	
	600V A	21	38	45	52	60	
	700V A	-	-	-	46	57	
	800V A	-	-	-	40	55	
	900V A	-	-	-	36	53	
	1000V A	-	-	-	33	51	
4 Pole in Serie + 2 Pole parallel A4+2 	350V A	29	45	58	80	85	
	500V A	29	45	58	71	85	
	600V A	29	45	50	65	82	
	700V A	-	-	-	58	76	
	800V A	-	-	-	51	71	
	900V A	-	-	-	45	67	
	1000V A	-	-	-	42	64	
AC-Rating "General use"	2 Pole in Serie 	600V A	16	25	32	40	55
	2 Pole in Serie + 2 Pole parallel 	277V A	-	-	50	72	85
	3 Pole parallel 	3x480V A	-	-	32	-	-
	Fuse size (RK5) Industrial Control Switch						
5kA / 600V	A	40	60	80	-	-	
5kA/1000V	A	-	-	-	160	160	
Anschlußquerschnitte (inkl. Verbinder LSV-B1)							
ein- oder mehrdrähtig	AWG	12 - 10	12 - 10	12 - 10	16 - 10	16 - 10	
feindrähtig	AWG	12 - 6	12 - 6	12 - 6	14 - 4	14 - 4	
feindrähtig (+ Aderendhülse)	AWG	12 - 6	12 - 6	12 - 6			
Klemmschraube		M4 Pz2	M4 Pz2	M4 Pz2	M5 Pz2	M5 Pz2	
Anzugsdrehmoment	lb.inch	9 - 16	9 - 16	9 - 16	22 - 25	22 - 25	
Schutzart der Anschlußklemmen ¹⁾			IP20	IP20	IP20	IP20	IP20

1) Schutzart der Anschlußklemmen mit angeschlossenem, isoliertem Leiter.

Approbationen

Land	USA, UL508I	US, Kanada UL508	Europa	TÜVRheinland	China CCC	CB-Zertifikate	EAC
Type							
LS16	o	o	/	o	o	o	o
LS25	o	o	/	o	o	o	o
LS32	o	o	/	o	o	o	o
LS40	o	o	/	-	-	o	o
LS55	o	o	/	-	-	o	o

o In Normalausführung approbiert / Approbation nicht erforderlich CE x zur Approbation eingereicht
- bisher nicht zur Approbation vorgesehen

Technische Daten

Maximal zulässiger Strom, abhängig von Umgebungstemperatur und Anschlußquerschnitten

Schalter offen LS16..., 2 Kontakte in Serie (A2)

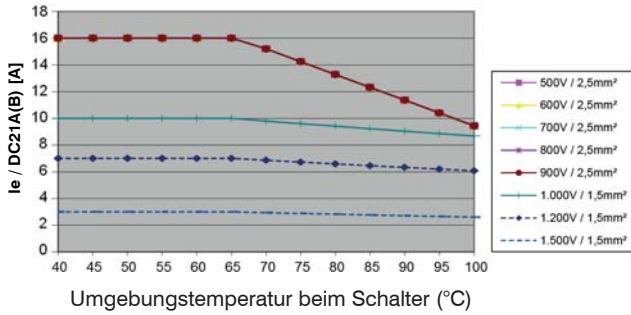

Schalter offen LS16 ..., 2 Kontakte in Serie + 2 parallel (A2+2)

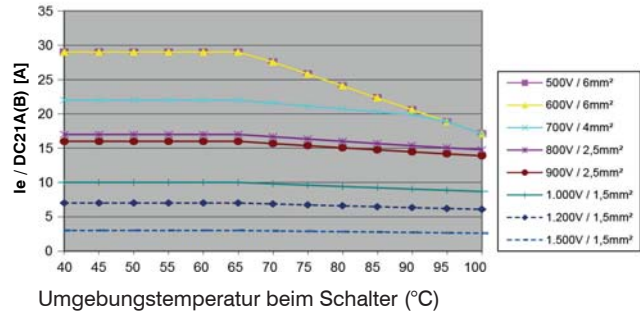

Schalter offen LS16..., 4 Kontakte in Serie (A4x)

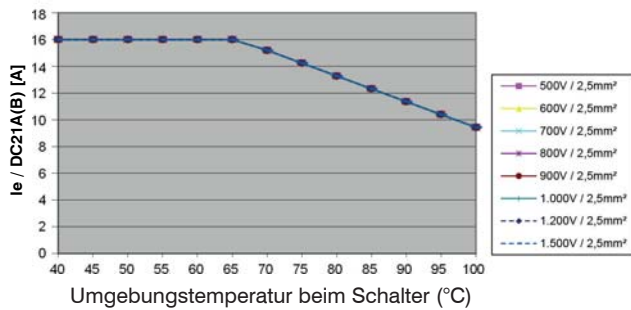

Schalter offen LS16..., 4 Kontakte in Serie + 2 parallel (A4+2)

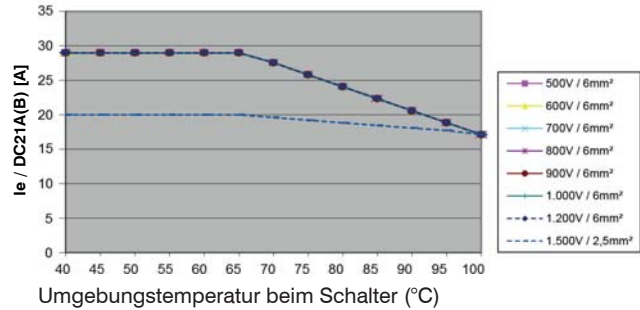

Schalter gekapselt LS16 PFL..., 2 Kontakte in Serie (A2)

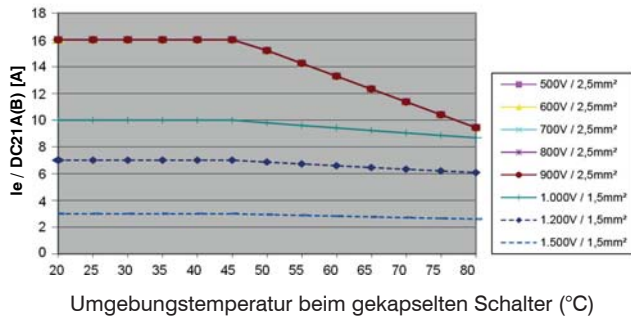

Schalter gekapselt LS16 PFL..., 2 Kontakte in Serie + 2 parallel (A2+2)

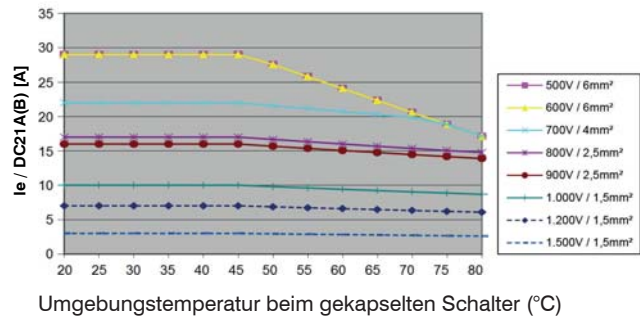

Schalter gekapselt LS16 PFL... 4 Kontakte in Serie (A4x)

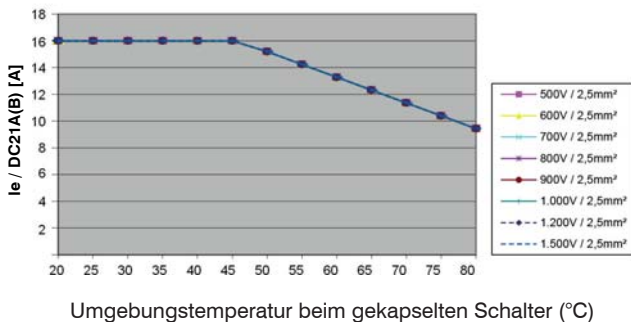

Schalter gekapselt LS16 PFL... 4 Kontakte in Serie + 2 parallel (A4+2)

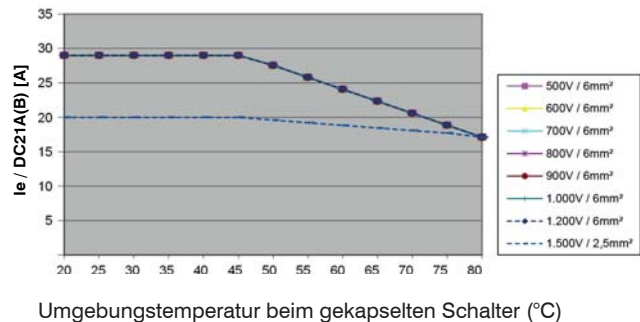

Technische Daten

Maximal zulässiger Strom, abhängig von Umgebungstemperatur und Anschlußquerschnitten

Schalter offen LS25..., 2 Kontakte in Serie (A2)

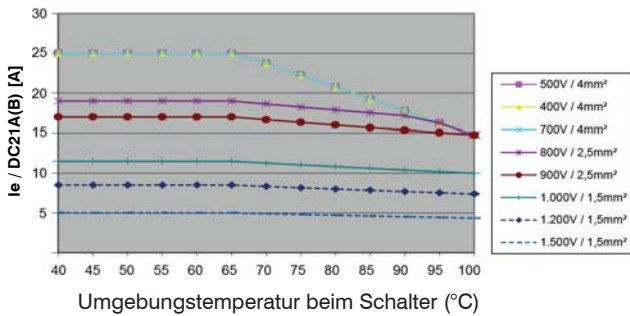

Schalter offen LS25 ..., 2 Kontakte in Serie + 2 parallel (A2+2)

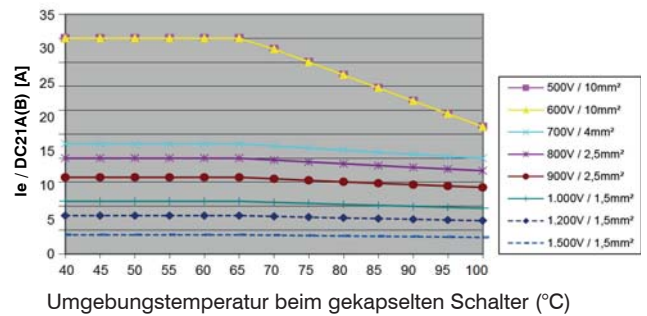

Schalter offen LS25..., 4 Kontakte in Serie (A4x)

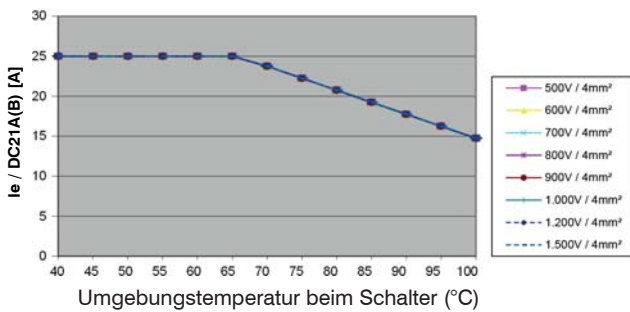

Schalter offen LS25..., 4 Kontakte in Serie + 2 parallel (A4+2)

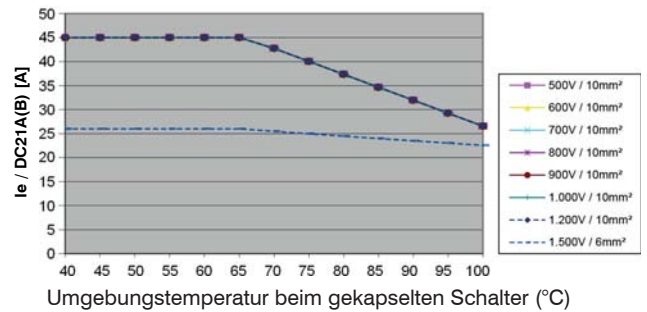

Schalter gekapselt LS25 PFL..., 2 Kontakte in Serie (A2)

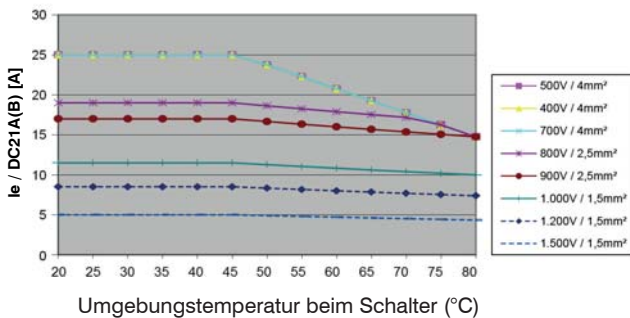

Schalter gekapselt LS25 PFL..., 2 Kontakte in Serie + 2 parallel (A2+2)

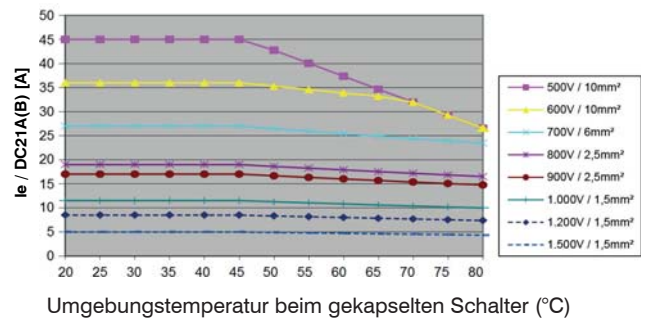

Schalter gekapselt LS25 PFL..., 4 Kontakte in Serie (A4x)

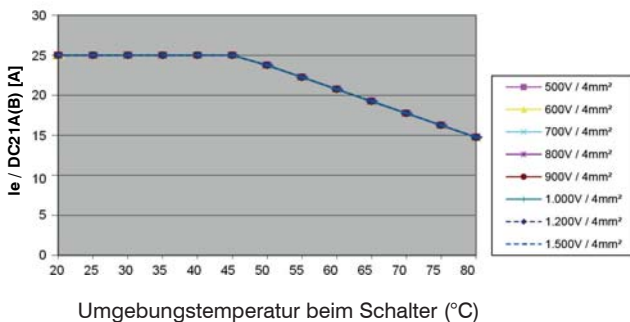

Schalter gekapselt LS25PFL..., 4 Kontakte in Serie + 2 parallel (A4+2)

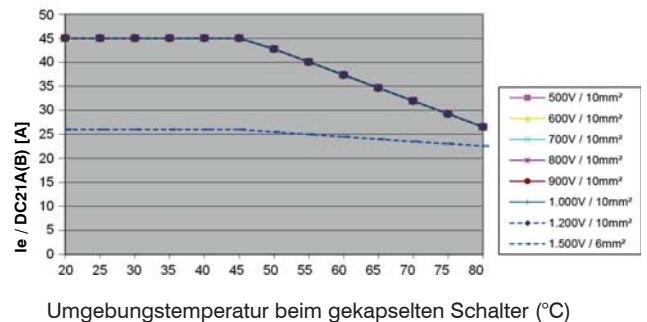

Technische Daten

Maximal zulässiger Strom, abhängig von Umgebungstemperatur und Anschlußquerschnitten

Schalter offen LS32..., 2 Kontakte in Serie (A2)

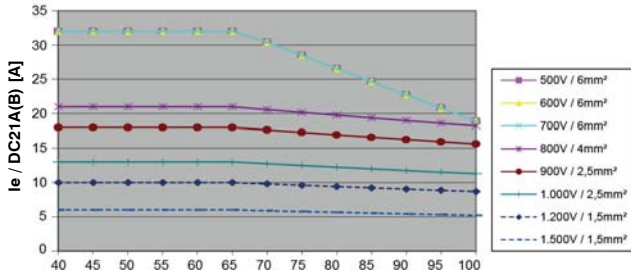

Umgebungstemperatur beim Schalter (°C)

Schalter offen LS32 ..., 2 Kontakte in Serie + 2 parallel (A2+2)

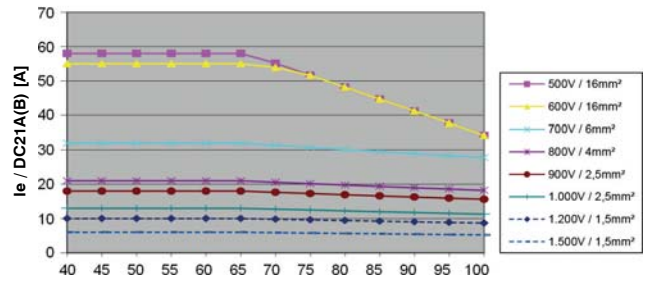

Umgebungstemperatur beim Schalter (°C)

Schalter offen LS32..., 4 Kontakte in Serie (A4x)

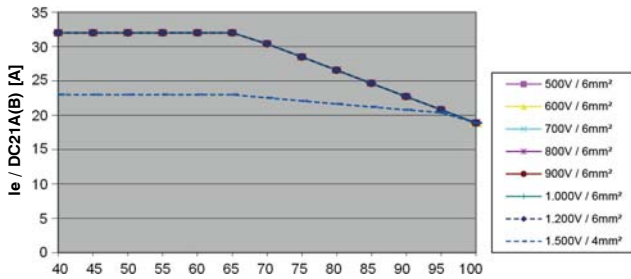

Umgebungstemperatur beim Schalter (°C)

Schalter offen LS32..., 4 Kontakte in Serie + 2 parallel (A4+2)

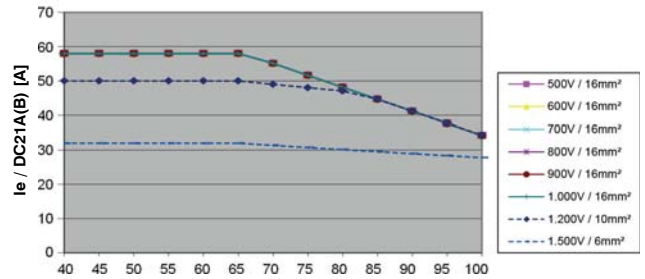

Umgebungstemperatur beim Schalter (°C)

Schalter gekapselt LS32 PFL..., 2 Kontakte in Serie (A2)

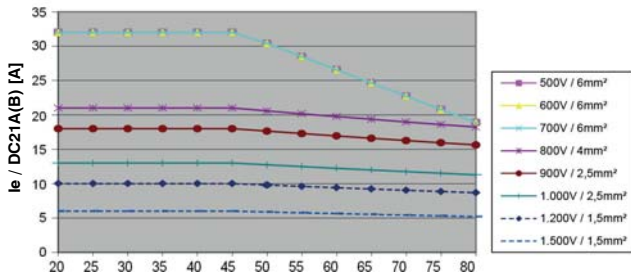

Umgebungstemperatur beim gekapselten Schalter (°C)

Schalter gekapselt LS32 PFL..., 2 Kontakte in Serie + 2 parallel (A2+2)

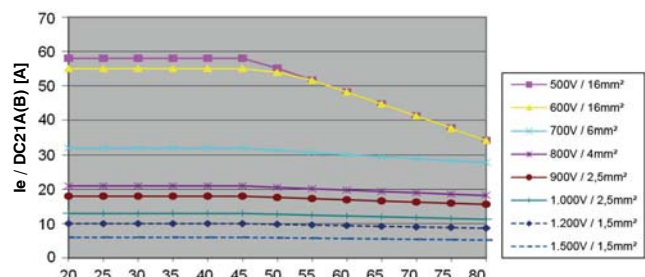

Umgebungstemperatur beim gekapselten Schalter (°C)

Schalter gekapselt LS32 PFL..., 4 Kontakte in Serie (A4x)

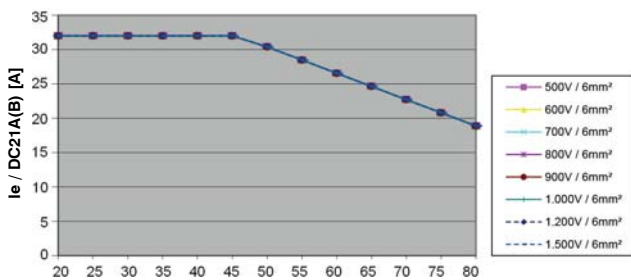

Umgebungstemperatur beim gekapselten Schalter (°C)

Schalter gekapselt LS32PFL..., 4 Kontakte in Serie + 2 parallel (A4+2)

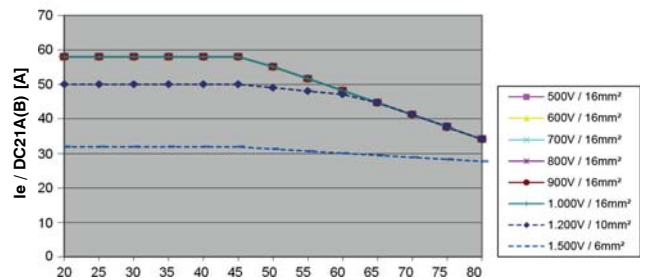

Umgebungstemperatur beim gekapselten Schalter (°C)

Technische Daten

Maximal zulässiger Strom, abhängig von Umgebungstemperatur und Anschlußquerschnitten

Schalter offen LS40..., 2 Kontakte in Serie (A2)

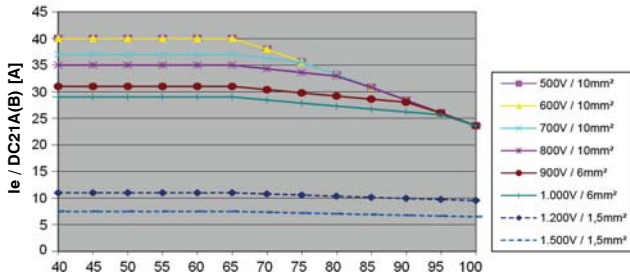

Umgebungstemperatur beim Schalter (°C)

Schalter offen LS40 ..., 2 Kontakte in Serie + 2 parallel (A2+2)

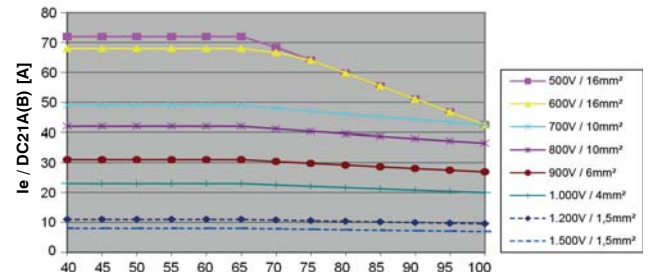

Umgebungstemperatur beim Schalter (°C)

Schalter offen LS40..., 4 Kontakte in Serie (A4x)

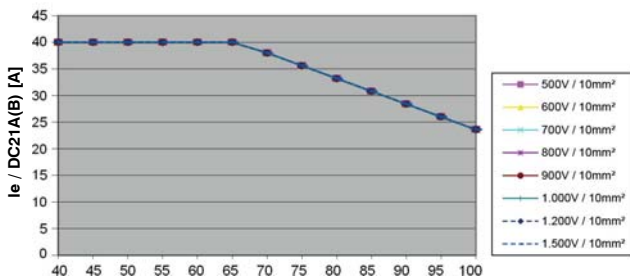

Umgebungstemperatur beim Schalter (°C)

Schalter offen LS32..., 4 Kontakte in Serie + 2 parallel (A4+2)

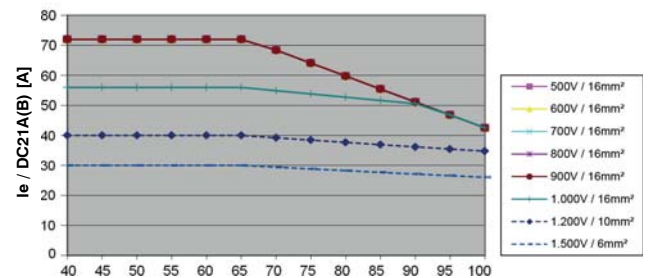

Umgebungstemperatur beim Schalter (°C)

Schalter gekapselt LS40 PFL..., 2 Kontakte in Serie (A2)

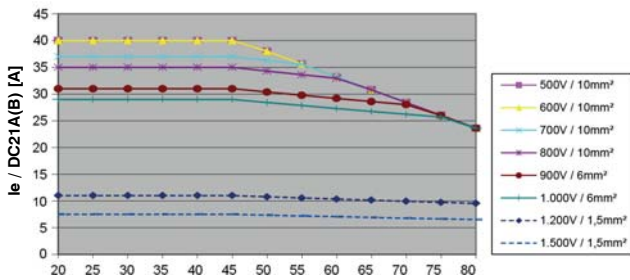

Umgebungstemperatur beim Schalter (°C)

Schalter gekapselt LS40 PFL..., 2 Kontakte in Serie + 2 parallel (A2+2)

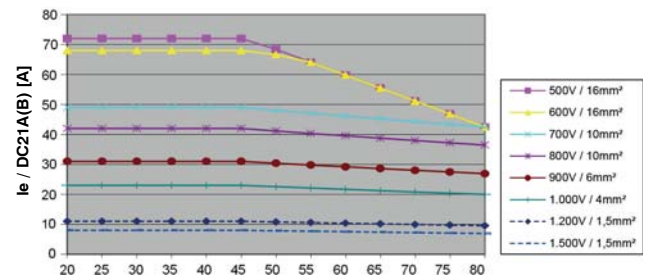

Umgebungstemperatur beim Schalter (°C)

Schalter gekapselt LS40 PFL..., 4 Kontakte in Serie (A4x)

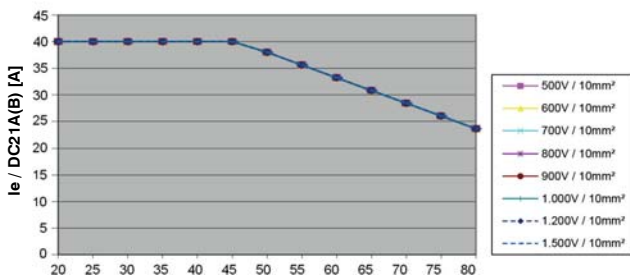

Umgebungstemperatur beim Schalter (°C)

Schalter gekapselt LS40 PFL..., 4 Kontakte in Serie + 2 parallel (A4+2)

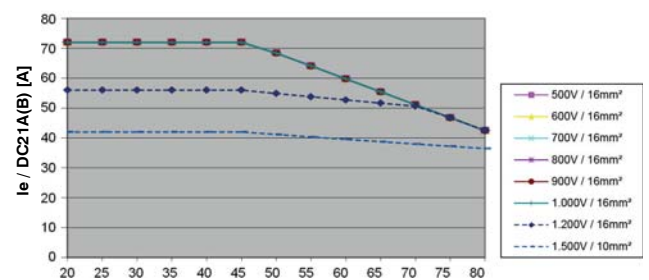

Umgebungstemperatur beim Schalter (°C)

Technische Daten

Maximal zulässiger Strom, abhängig von Umgebungstemperatur und Anschlußquerschnitten

Schalter offen LS55..., 2 Kontakte in Serie (A2)

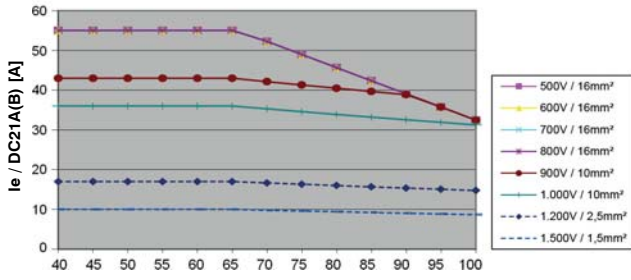

Umgebungstemperatur beim Schalter (°C)

Schalter offen LS55 ..., 2 Kontakte in Serie + 2 parallel (A2+2)

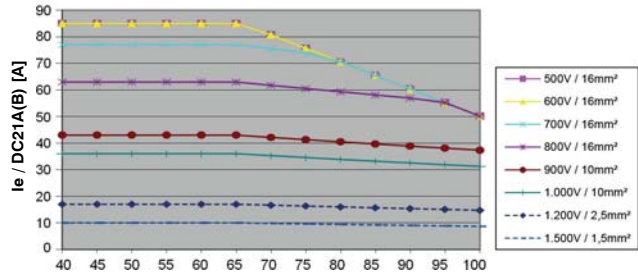

Umgebungstemperatur beim Schalter (°C)

Schalter offen LS55..., 4 Kontakte in Serie (A4x)

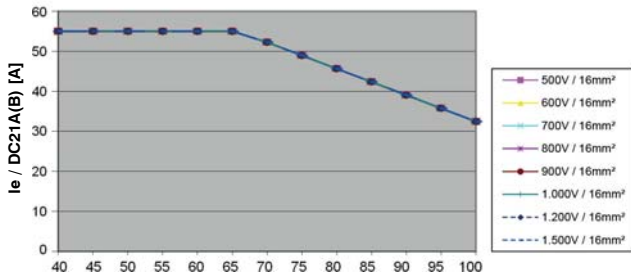

Umgebungstemperatur beim Schalter (°C)

Schalter offen LS55 ..., 4 Kontakte in Serie + 2 parallel (A4+2)

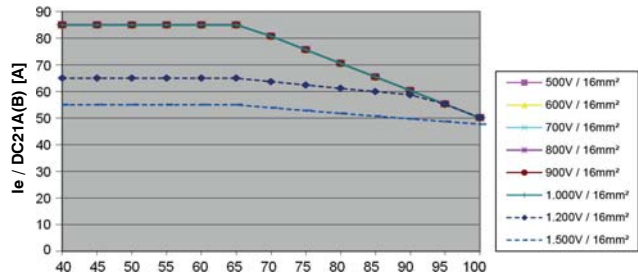

Umgebungstemperatur beim Schalter (°C)

Schalter gekapselt LS55 PFL..., 2 Kontakte in Serie (A2)

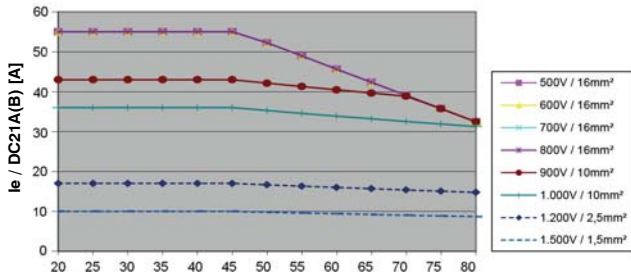

Umgebungstemperatur beim Schalter (°C)

Schalter gekapselt LS55 PFL..., 2 Kontakte in Serie + 2 parallel (A2+2)

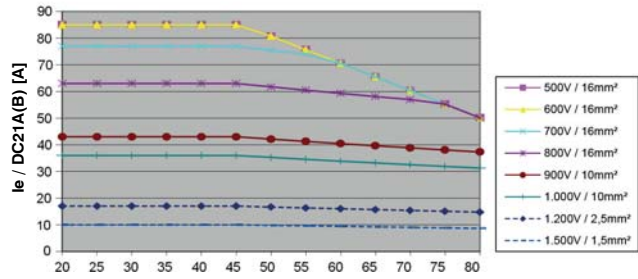

Umgebungstemperatur beim Schalter (°C)

Schalter gekapselt LS55 PFL..., 4 Kontakte in Serie (A4x)

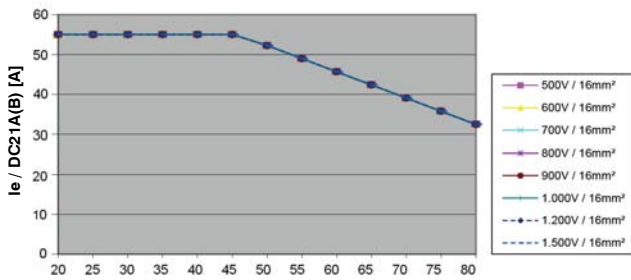

Umgebungstemperatur beim Schalter (°C)

Schalter gekapselt LS55 PFL..., 4 Kontakte in Serie + 2 parallel (A4+2)

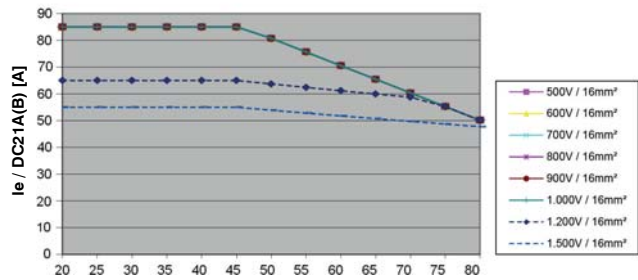

Umgebungstemperatur beim Schalter (°C)

Abmessungen

**LS16 E.., LS25 E.., LS32 E..,
..A2 ..A2+2, ..A4.**

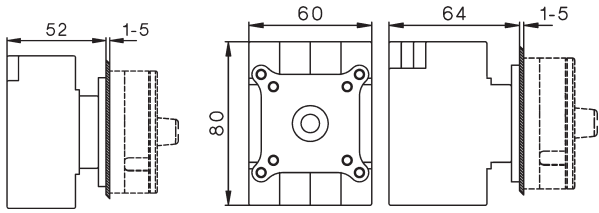

**LS16 E.., LS25 E.., LS32 E..,
..A6, ..A8, ..A3+2, ..A4+2**

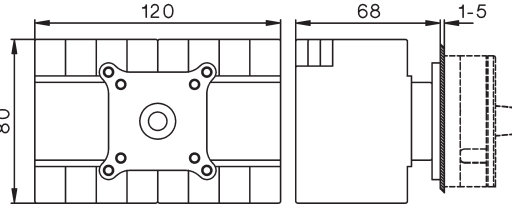

**LS... +VW“x“
Verlängerte Schalterwelle**

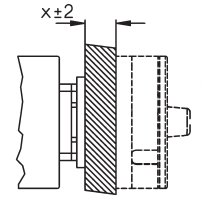

**LS40 E.., LS55 E..
..A2, ..A2+2, ..A4.**

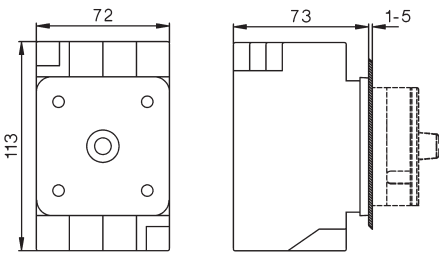

**LS40 E.., LS55 E..
..A6, ..A8, ..A3+2, ..A4+2**

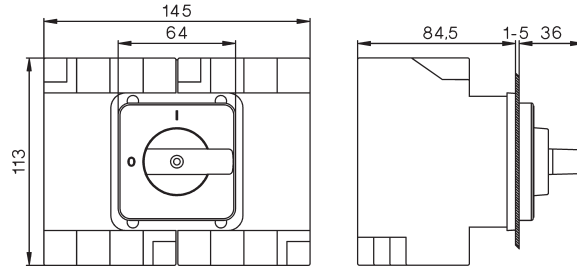

**Bohrplan
Montageschraube
S3631N M=1,2-1,4 Nm**

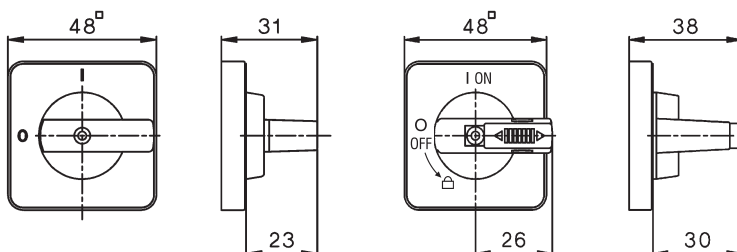
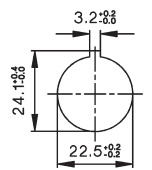
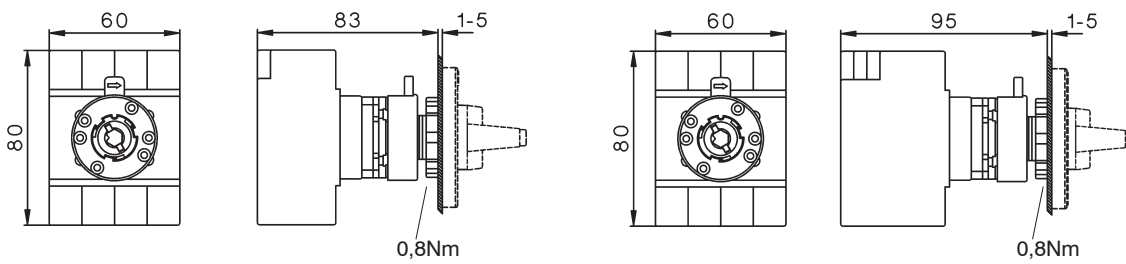
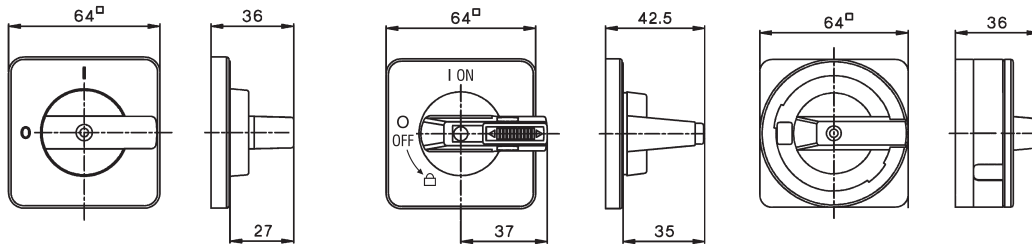
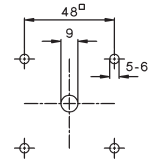

Abmessungen

LS16 Z..., LS25 Z..., LS32 Z...,
..A6, ..A8, ..A3+2, ..A4+2

LS.. ZO..

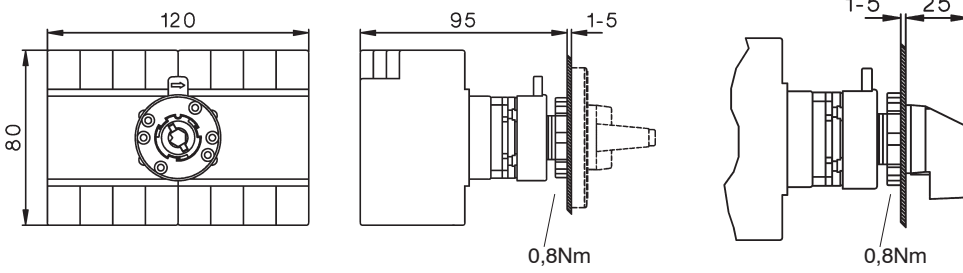

LS16 VZV..., LS25 VZV..., LS32 VZV...,
..A2, ..A2+2, ..A4

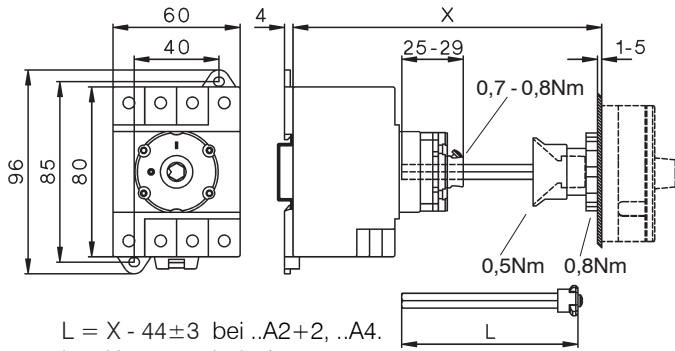

$L = X - 44 \pm 3$ bei ..A2+2, ..A4.
 $L = X - 32 \pm 3$ bei ..A2

Lieferlänge bei: ..A2+2, ..A4.
 $X_{\max} = 194, L = 150$
($X_{\min} = 89$)

Lieferlänge bei: ..A2
 $X_{\max} = 182, L = 150$
($X_{\min} = 77$)

größere X-Maße auf Anfrage

LS16 VZV..., LS25 VZV..., LS32 VZV...,
..A6, ..A8, ..A3+2, ..A4+2

Bohrplan

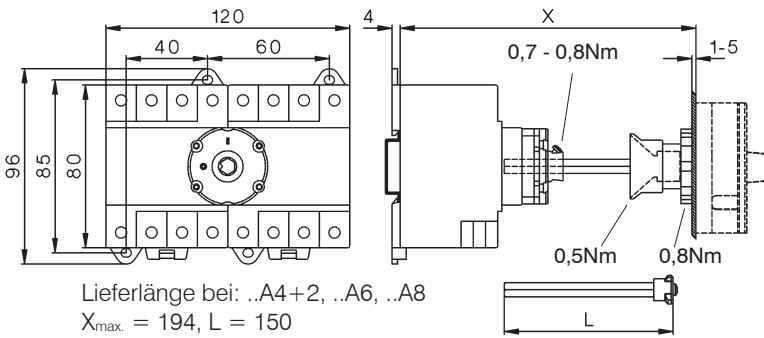

Lieferlänge bei: ..A4+2, ..A6, ..A8
 $X_{\max} = 194, L = 150$
($X_{\min} = 95$)

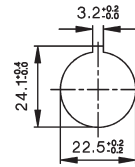

$L = X - 49 \pm 3$

LS40 VZV..., LS55 VZV..
..A2, ..A2+2, ..A4.

LS40 VZV..., LS55 VZV..
..A6, ..A8, ..A3+2, ..A4+2

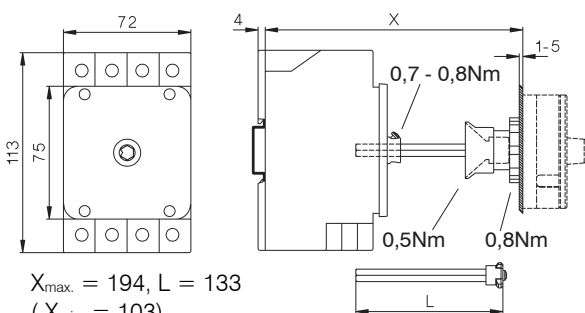

$X_{\max} = 194, L = 133$
($X_{\min} = 103$)

$L = X - 61 \pm 3$

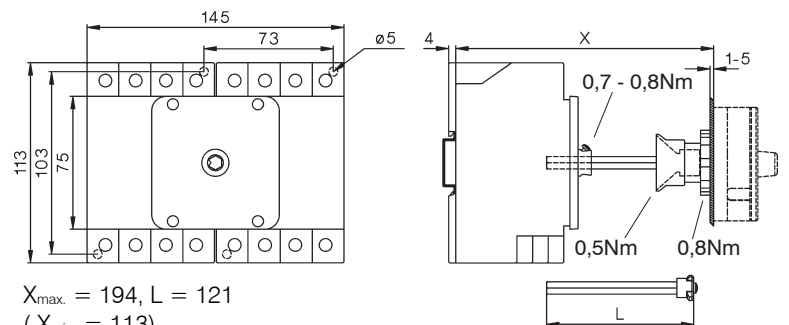

$X_{\max} = 194, L = 121$
($X_{\min} = 113$)

$L = X - 73 \pm 3$

Abmessungen

LS16 SMA..., LS25 SMA..., LS32 SMA...,
..A2 ..

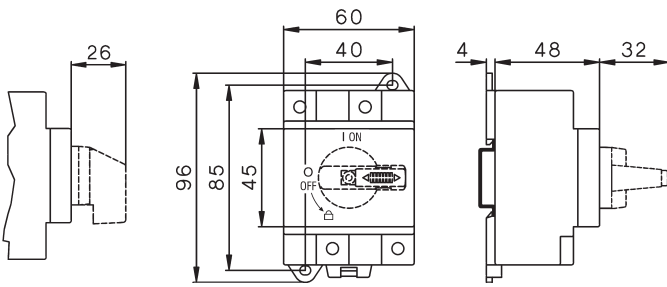

A2+2, ..A4.

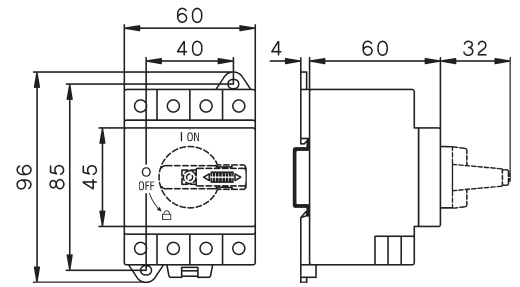

LS40 SMA..., LS55 SMA..
..A2, ..A2+2, ..A4.

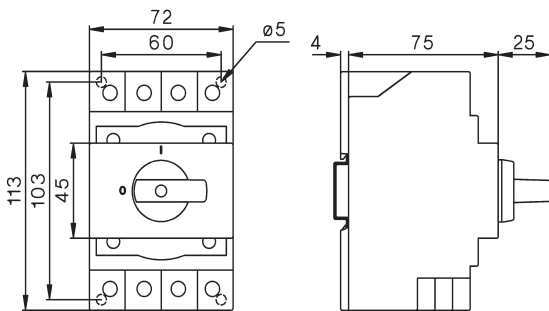

LS40 SMA..., LS55 SMA..
..A6, ..A8, ..A3+2, ..A4+2

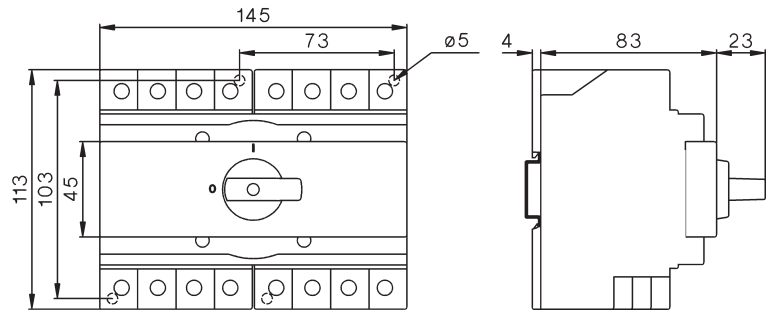

LS16 SMA..., LS25 SMA..., LS32 SMA...,
..A6, ..A8, ..A3+2, ..A4+2

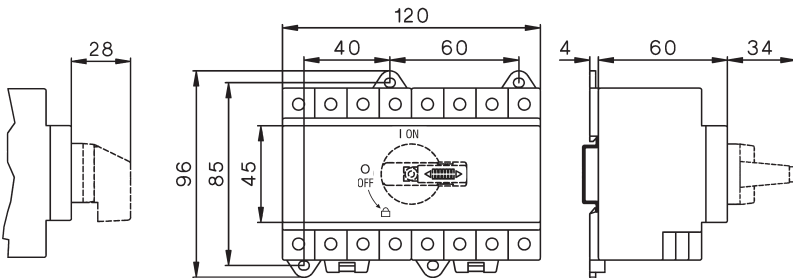

LS.. SMAH1.. mit niedrigem Griff
A2+SV1N

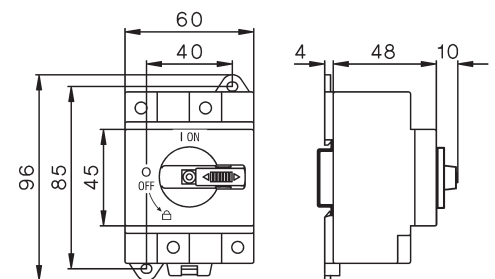

LS16 SMAH1..., LS25 SMAH1, LS32 SMAH1 mit niedrigem Griff
A2+2 +SV1N, A4.+SV1N

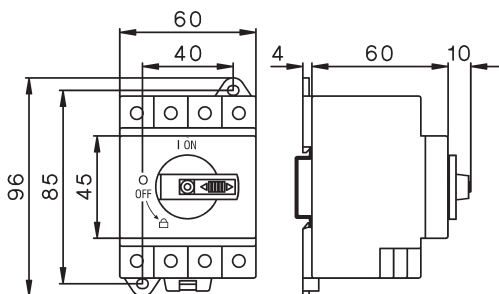

A4+2 +SV1N, A6+SV1N, A8+SV1N

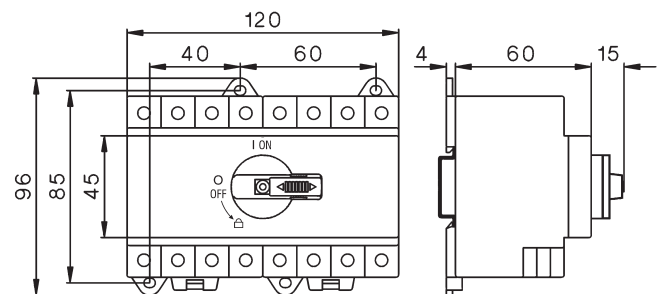

Abmessungen

LS16 PFL..., LS25 PFL..., LS32 PFL..
..A2, ..A2+2, ..A4.

Hauptschalter (versperrbar)
LS..PFLH4 A..

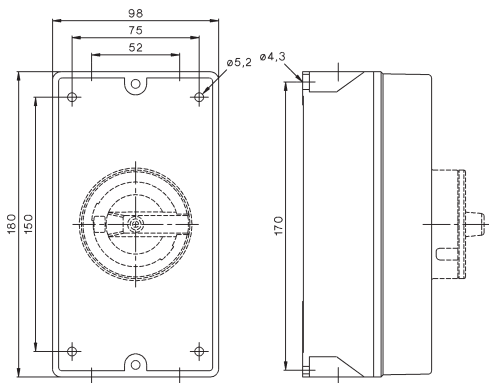
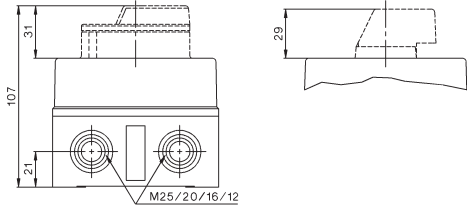

LS16 PFL..., LS25 PFL..., LS32 PFL..
..A2, ..A2+2, ..A4.
+ M25

Hauptschalter (versperrbar)
LS..PFLH4 A..

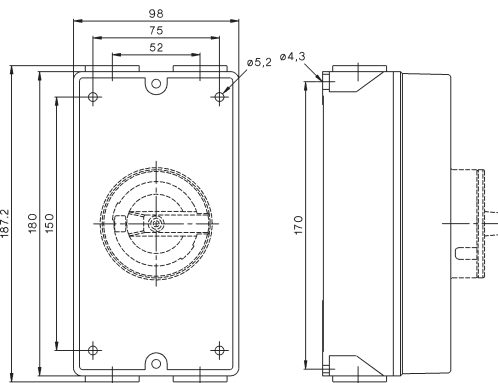
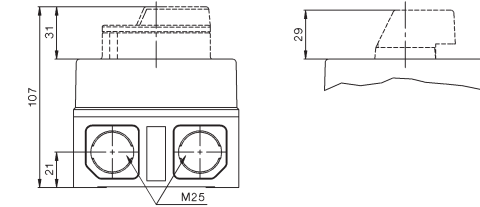

LS16 PFL..., LS25 PFL..., LS32 PFL.. LS40 PFL..., LS55 PFL..
..A6, ..A8, ..A3+2, ..A4+2 ..A2, ..A4, ..A6, ..A8, ..A2+2, ..A3+2, ..A4+2
Hauptschalter (versperrbar)
LS..PFLH4 A..

